



EAST COAST RAILWAY

WALT AIR DIVISION

STATION WORKING RULES
OF

MACHKUND ROADSTATION

INDEX

| <u>S No</u> | <u>DESCRIPTION</u> | <u>PAGE No</u> |
|-------------|--------------------------------|----------------|
| 1. | Station Working Rules ----- | 1-14 |
| 2. | Appendix-A ----- | 15 |
| 3. | Appendix-B ----- | 16-42 |
| 4. | Appendix-C ----- | 43 |
| 5. | Appendix-D ----- | 44-45 |
| 6. | Appendix-E ----- | 46 |
| 7. | Appendix-F ----- | 47 |
| 8. | Appendix-G ----- | 48 |

EAST COAST RAILWAY

WALTAIR DIVISION

STATION WORKING RULES OF MACHKUND ROAD [MKRD][BROAD GAUGE]

No.WTP/5/SWR/MKRDDate of Issue:

Date brought in force:

NOTE: -The Station Working Rules must be read in conjunction with General&Subsidiary rules, Block Working Manual and Operating Manual. These rules do not in any way supersede any rule in the above books.

(1) STATION WORKING RULE DIAGRAM:

- Station Working Rule Diagram No:- SI/WRD/23211 ALT-'B'With SPL Note- S1
- CSTE/E.Co.Rly/DRG No:-SI-23211 ALT-'B'With SPL Note- S1
- Date up to which corrected:

(2) DESCRIPTION OF STATION:**2.1. GENERAL LOCATION:**

| | | |
|----|---|--|
| a) | Name of the station | MACHKUND ROAD (MKRD) |
| b) | Class of station | 'B' class |
| c) | Section | Kottavalasa-Kirandul |
| d) | Double Line/Single Line / Multiple Line | Double line. |
| e) | Electrified/Non-Electrified | Electrified |
| f) | Gauge BG/MG/NG | BG |
| g) | Railway | East Coast Railway |
| h) | Route | 'D' Special |
| i) | Situated at | Km 158.593 |
| j) | Reckoned from | Kottavalasa |
| k) | Operation | Centrally operated with Visual Display Unit (VDU). |
| l) | Type of Interlocking | Standard II (R) |

2.2. BLOCK STATIONS, IBH, IBS ON EITHER SIDE AND THEIR DISTANCE AND OUT LYING SIDINGS:

| S.No | Adjacent BlockStation | Distance | Direction |
|------|-----------------------------|----------|-----------|
| 1. | PALIBA | 12.564km | KRDlend |
| 2. | BHEJA | 11.396km | KTV end |
| 3. | Provision of IBS | Nil | |
| 4. | Automatic signal | Nil | |
| 5. | DK station/Outlying sidings | Nil | |
| 6. | Passenger halt | Nil | |

2.3. BLOCK SECTION LIMITS ON EITHER SIDE OF THE STATION ON DIFFERENT DIRECTIONS:

| Between Stations | The Point from which the Block section commences | The Point at which the 'Block Section' ends |
|---------------------------|---|---|
| MKRD-BHJA DN Direction | The advance block section commences at DN advanced starter signal No.26 of MKRD on DN line. | Ends at Facing point No.32A on Down line of BHJA. |
| BHJA-MKRD | The rear block section | Ends at Facing point |

| | | |
|--------------------------|---|---|
| UP Direction | commences at Up advanced starter signal No.25 of BHJA on Up line. | No.35A on Up line of MKRD. |
| MKRD-PBV UP Direction | The advance block section commences at UP advanced starter signal No.25 of MKRD on UP line. | Ends at Facing point No.31A on Up line of PBV. |
| MKRD-PBV DN Direction | The advance block section commences at DN advanced starter signal No.26 of PBV on DN line. | Ends at Facing point No.34A on Down line of MKRD. |

2.4. GRADIENTS:

| Station towards | Chainage | | Inter distance | Gradient | |
|-----------------|----------|---------------|------------------|------------------|---------------------|
| | From | To | | | |
| MKRD-PBV | UP | 0.000 F/CSB | 875.89M | 875.89M | 1 in 400 Raising |
| | | 875.89M | 1200.89M | 325.00M | 1 in 121 Raising |
| | | 1200.89M | 1275.89M | 75.00M | LEVEL |
| | | 1275.89M | 3200.89M | 1925.00M | 1 in 101 Raising |
| | | 3200.89M | Into section | --- | 1 in 288.18 Falling |
| | DN | Chainage | | Inter distance | Gradient |
| | | From | To | | |
| | | 0.000 F/CSB | 575.89M | 575.89M | 1 in 400 Raising |
| | | 575.89M | 775.89M | 200.00M | 1 in 190.24 Raising |
| | | 775.89M | 875.89M | 100.00M | 1 in 125 Raising |
| | | 875.89M | 1150.89M | 275.00M | 1 in 105 Raising |
| | | 1150.89M | 1300.89M | 150.00M | LEVEL |
| | | 1300.89M | 1650.89M | 350.00M | 1 in 105 Raising |
| | | 1650.89M | 2100.89M | 350.00M | 1 in 100 Raising |
| | | 2100.89M | 2350.89M | 250.00M | 1 in 113 Raising |
| | | 2350.89M | 3250.89M | 900.00M | 1 in 100 Raising |
| | | 3250.89M | Into section | --- | 1 in 500 Falling |
| MKRD-BHJA | UP | Chainage | | Inter Distance | Gradient |
| | | From | To | | |
| | | 0.000 F/CSB | 304.14M | 304.14M | 1 in 400 Falling |
| | | 304.14M | 585.11M | 280.97M | 1 in 572 Falling |
| | | 585.11M | 724.11M | 139.00M | LEVEL |
| | | 724.11M | 999.11M | 275.00M | 1 in 129 Raising |
| | | 999.11M | 1274.11M | 275.00M | 1 in 500 Raising |
| | | 1274.11M | 2274.11M | 1000.00M | 1 in 110 Raising |
| | | 2274.11M | 2449.11M | 175.00M | 1 in 170 Falling |
| | 2449.11M | 3549.11M | 1100.00M | 1 in 100 Falling | |
| | 3549.11M | In to section | -- | 1 in 115 Falling | |
| | DN | Chainage | | Inter Distance | Gradient |
| | | From | To | | |
| | | 0.000 F/CSB | 304.14M | 304.14M | 1 in 400 Falling |
| | | 304.14M | 605.00M | 300.86M | 1 in 572 Falling |
| | | 605.00M | 824.11M | 219.11M | 1 in 184 Raising |
| | | 824.11M | 1049.11M | 225.00M | 1 in 200 Raising |
| 1049.11M | | 2249.11M | 1200.00M | 1 in 121 Raising | |
| 2249.11M | | 2424.11M | 175.00M | 1 in 197 Raising | |
| 2424.11M | 3274.11M | 850.00M | 1 in 100 Falling | | |

| | | | | | |
|--|--|----------|---------------|----|------------------|
| | | 3274.11M | In to section | -- | 1 in 103 Falling |
|--|--|----------|---------------|----|------------------|

2.5. LAY OUT:

A) RUNNING LINES IN THE MAIN YARD:

| S No | Name of the Line | Electrified/Non Electrified | Platforms with Length |
|------|---------------------|-----------------------------|------------------------------|
| 1. | Line No.1(DN Loop) | Electrified | High Level (400M x 6.10M) |
| 2. | Line No.2 (DN Main) | Electrified | -- |
| 3. | Line No.3 (UPLoop) | Electrified | -- |
| 4. | Line No.4 (UP Main) | Electrified | High Level (400M x 6.10M) |

B) SIDINGS:

| S.No | Name of the Siding | Electrified /Non Electrified | Platforms with Length | Isolation from Running line | Description of Siding |
|------|--------------------|------------------------------|-----------------------|--|---|
| 1. | Sub Station Siding | Electrified | -- | Isolated from Line No.1 by DS with Motor operated. | Sub Station Siding takes off from Line No.1 towards Station end with CSL of 58M (DS to GJ). (Details given in the Para No.20 & 20.1 of Appendix-B of this SWR). |
| 2. | Hot Axle Siding | Electrified | -- | Isolated from Line No.1 by DS with Motor operated. | Hot Axle Siding takes off from Line No.1 towards BHJA end with CSL of 57M (GJ to DS). (Details given in the Para No.19 & 19.1 of Appendix-B of this SWR). |

2.5.1. RUNNING LINES, DIRECTION OF MOVEMENT & HOLDING CAPACITY IN CSL:

| S.No | Name of the Line | Holding Capacity in CSL | Direction of movements |
|------|---------------------|-------------------------|--|
| 1. | Line No.1(DN Loop) | 746M (STR to SS) | a) Trains coming from BHJA and proceeding towards PBV are UP trains. b) Trains coming from PBV and proceeding towards BHJA are DN trains. |
| 2. | Line No.2 (DN Main) | 783M (STR to SS) | |
| 3. | Line No.3 (UPLoop) | 734M (SS to STR) | |
| 4. | Line No.4 (UP Main) | 811M(SS to STR) | |

2.5.2. NON-RUNNING LINES AND THEIR CAPACITY IN CSL:

| S.No | Name of the Line | Holding Capacity in CSL | Whether Electrified/Non-Electrified |
|------|--------------------|-------------------------|-------------------------------------|
| 1. | Sub Station Siding | 58M (DS to GJ) | Electrified |
| 2. | Hot Axle Siding | 57M (GJ to DS) | Electrified |

2.5.3. ANY SPECIAL FEATURES IN THE LAYOUT:

---NIL--

2.6. LEVEL CROSSINGS:

--- NIL---

(3) SYSTEM AND MEANS OF WORKING: -

| | |
|---|---|
| <i>System of Working in force</i> | Absolute Block System of Working. |
| <i>Double Line/Single Line</i> | Double Line. |
| <i>Block Instruments</i> | a) MKRD-BHJA Section: SGE type Double line Lock and Block Instrument. b) MKRD-PBV section: SGE type Double line Lock and Block Instrument. |
| <i>Co-operative/Non-Co-operative</i> | a) MKRD-BHJA Section: Non-Co-operative. b) MKRD-PBV Section: Non-Co-operative. |
| <i>Block Telephones</i> | Attached with Block Instruments. |
| <i>Staff responsible for custody of key and operations.</i> | SM on duty |

(4) SYSTEM OF SIGNALLING AND INTERLOCKING:

| | | |
|----|--|---|
| 1. | <i>Standard of Interlocking</i> | Standard-II (R). |
| 2. | <i>Type of signaling</i> | MACLS |
| 3. | <i>Mode of operating the signals</i> | Electronic Interlocking (Visual Display Unit) |
| 4. | <i>Provision of Calling-On signals</i> | Calling-on signals are provided below Homesignals(i.e., in both UP & Down directions) as per GR.3.13 (1)(b), (2)(3)(4) & (6) (b). |
| 5. | <i>Provision of shunt signals</i> | Shunt back signals SH3(A/B) and SH4(A/B) are provided towards BHJA end of the yard and towards PBV end of the yard respectively. Dependent shunt signals SH9 & SH11 are provided on Line No.1 & 2 towards PBV end respectively and SH10 & SH12 are provided on Line No.4 & 3 towards BHJA end respectively. |
| 6. | <i>Emergency Cross-over</i> | Nil |
| 7. | <i>Track circuits</i> | The provision of track circuits is mentioned in Appendix-B Para No.10 of this SWR. |
| 8. | <i>Axle counters</i> | Provided High availability Single Section Digital Axle counter (HASSDAC) for last vehicle verification between MKRD-BHJA and MKRD-PBV Sections on both UP and DN Lines respectively. Single Section Digital Axle counter (SSDAC) provided on DN Line of Bridge No.487 at Km.157.884 due to presence of Girder Bridge. |
| 9. | <i>Crank Handles</i> | When any point fails to operate normally by the Route Setting operation through VDU, it is inevitable to operate the points with crank handle. The SM on duty shall personally ensure clamping and padlocking of all facing and trailing points on the route. Crank handles are interlocked with signals and interlocking system. When points |

| | | |
|-----|--|--|
| | | <p>become defective, the signals controlling these points shall be considered defective and vice-versa and the procedure for use of crank handle for motor operated points shall be followed as per operating manual chapter-2, para-2.18 & 2.19 and Para No. 4.7 of Appendix-B.</p> <p>CH1 : 35A/B CH2 : 32A/B CH3 : 33A/B CH4 : 34A/B CH5 : 37A/B CH6 : 41A/B</p> |
| 10. | <i>Emergency Point operation</i> | Emergency point operation facility is provided to operate the point from the VDU in case of failure of point controlling track circuit/Axle Counter. Each operation of emergency point operation shall be recorded in the station diary and in the register meant for this purpose. |
| 11. | <i>Showing of Veeder Counter</i> | The counters as mentioned in the Para No.9 of Appendix-'B' are provided in this station for record the Emergency operations. The increment in counter number for each and every such action should be recorded by the SM on duty who shall record the details of the operation along with the latest counter number in a register. |
| 12. | <i>Emergency Route Release operation</i> | All the signals in this station are provided with 'DEAD APPROACH LOCKING'. As such when a route is set and signal is taken 'OFF' on the route, the route gets locked. Normally the route is released by the passage of the train over the route. When it becomes necessary to alter the route after the signal has been taken 'OFF' vide SR 3.36.02(a), Emergency route release operation procedure as mentioned in Para No.5.1 of Appendix-'B' in this SWR shall be followed. |
| 13. | <i>Emergency Crank Handle Release operation.</i> | Emergency crank handle release operation facility is provided to operate the point by using the crank handle in case of Route locked condition. For Emergency crank handle operation the procedure laid down in Para No.5.3 of Appendix-'B' shall be followed. Each operation of emergency crank handle operation shall be recorded in the station diary and in the register meant for this purpose. |

4.1. CUSTODY OF RELAY ROOM KEY AND PROCEDURE FOR ITS HANDING OVER AND TAKING OVER BETWEEN STATION MASTER AND S&T MAINTENANCE STAFF:

Custody of Relay room key and procedure for its handover and taking over between SM and S&T staff has to follow the procedure as per JPO issued by COM and CSTE vide No. JPO/02/2012 dated 29.08.2012. Relay room is provided with two independent locks. The key of one lock shall be in the personnel custody of Station Master on duty and the key of other lock shall be in the custody of S&T Maintainer. In the event of necessity such as for attending failure, or regular maintenance, on being requisitioned by S&T maintainer, SM shall hand over the key to the Maintainer. On completion of the work, maintainer shall lock the relay room and shall return the key to SM. The

particulars of such transactions shall be entered by the SM in the relay room key register vide OM 2015 Para No.13.16.

4.2. POWER SUPPLY:

The power supply arrangement for this station is described in detailed in the Para No.27& 28of APPENDIX-B.

(5) TELECOMMUNICATIONS:

- a) The station is connected to Kottavalasa-Koraput control Circuit.
- b) The station is connected to Kottavalasa-Koraput traction power control circuit.
- c) Railway Auto Telephone provided at the station is connected to Divisional Exchange at WAT through Exchange at JDB.
- d) Telephones attached to Double line lock and block Instruments are connected to adjacent stations on either side.
- e) Telephone communication is provided between MKRD-PBV and MKRD-BHJA stations.
- f) Telephone communication is provided between Station Master on duty and UP CH locations, DN CH Locations, HA Location No.1 & 2, Siding point Location No.1 & 2.
- g) Telephone communication is provided between Station Master on duty and Axle Counter Zone Verification box.
- h) 25w VHF set is provided at the station for emergency communication.
- i) CUG telephone is provided at the station.

5.1. FAILURE OF COMMUNICATION:

- a) In the event of total failure of communications between the adjacent block stations SR 6.02.03 shall be observed for double line section for working the train.
- b) In the event of partial interruption/failure of communications between the adjacent block stations SR 6.02.06 shall be observed for working the train.

(6) SYSTEM OF TRAIN WORKING:

6.1. DUTIES OF TRAIN WORKING STAFF:

The duties of Train working operational staff are detailed in Appendix-‘D’ of this SWR.

6.1.1. TRAIN WORKING STAFF IN EACH SHIFT:

| COMPLEMENT OF STAFF | STAFF IN EACH SHIFT |
|---------------------|---------------------|
| Station Master | 1 |
| Traffic Points Man | 1 |

The above staff shall work as per roster issued from time to time by Divisional Railway Manager (P) and these rosters shall be conspicuously displayed in the Station Master’s office.

6.1.2. RESPONSIBILITY FOR ASCERTAINING CLEARANCE OF LINES AND ZONES OF RESPONSIBILITY:

The SM on duty is responsible to ascertain the clearance of the nominated line between first facing point and advanced starter signal in each direction.The

private number book should be under the custody of SM on duty that is authorized to use it.

6.1.3. ASSURANCE OF THE STAFF IN THE ASSURANCE REGISTER:

All staff before taking up independent charge of their duties at this station shall, make a written declaration in the Assurance Register that they have read the SWR thoroughly and understood the system of working in force at the station and must sign such declaration.

No Railway servant shall be entrusted with any duty involving the safety of the public unless the SM (In-Charge) is satisfied that the concerned staff is competent for the post. No Railway servant unless duly examined and certified shall be allowed to work the points and signals. The SM (In-Charge) is responsible to see that all the staff are well conversant with the Station Working Rules of the Station and their signature obtained in the Assurance Register after he is satisfied that they have thoroughly understood the working Rules of the Station. In case of Class-IV staff, their signature/thumb impression must be obtained after explaining full about their duties and responsibility.

The SM (In-Charge) is personally responsible for maintaining the Assurance Register and for obtaining declaration from the staff working under him. The Assurance Register must be maintained in two parts one for Group-‘C’ staff and other for Group-‘D’ staff & duplicate copy of the Assurance Register must be maintained and kept in the personal custody by the SM (In-Charge).

Fresh assurance shall be obtained in the Assurance Register when:

1. He joins at the station as a new member.
2. There is any change in the Station Working Rules.
3. He resumes duty at the station after an absence of 15 consecutive days or more.

6.2. CONDITIONS FOR GRANTING LINE CLEAR:

- a) The trains are worked under Absolute block system of working with Double line between MKRD-PBV&MKRD-BHJA and MACLS signaling vide GR 8.03.
- b) Adequate distances for reception of trains in this station as follows.

| Line No. | Up Trains | | DN trains | |
|------------------------|------------------------------------|--|------------------------------------|--|
| | From | To | From | To |
| Line No.1 (DN Loop) | ---- | ---- | DN Loop Starter Signal No.10 | The end of Overrun Line OR DN Advanced Starter Signal No.26 |
| Line No.2 (DN Main) | ---- | ---- | DN Main Starter Signal No.12 | DN Advanced Starter Signal No.26 |
| Line No.3 (UP Loop) | UP Main Starter Signal No.11 | The end of Overrun Line OR UP Advanced Starter Signal No.25 | ---- | ---- |
| Line No.4 (UP Main) | UP Main Starter Signal No.9 | UP Advanced Starter Signal No.25 | ---- | ---- |

6.2.1. ANY SPECIAL CONDITIONS TO BE OBSERVED WHILE RECEIVING ORDESPACTHING A TRAIN: -

--NIL--

6.2.1.1. SETTING OF POINTS AGAINST BLOCKED LINE:

When a running line is blocked by stabled load wagon, vehicle or by a train which is to cross or give precedence to another train or immediately after the arrival of a train at the station etc., the points in rear end should immediately be set against the blocked line except when shunting or any other movement is required to be done on that line [Refer SR.3.51.06 (a)].

Safety Point Alarm Unit (SPAU):

A safety Point Alarm is provided on the VDU table with different indications:

1. On complete arrival of a train at the station, the SM has to set the Points immediately against the occupied line.
2. In case the SM forgets to alter the points, after a time lag of 02 minutes, an audible buzzer will be heard from this instrument along with the 'RED' indication of the line on which the train has arrived.
3. The SM shall then press 'ACK' button to mute the buzzer, and immediately set the required points against the line on which the train has arrived.
4. On setting the points against the occupied line, the RED indication will disappear.

If all the lines of a station happen to be blocked, when line clear has been granted to a train, the points should be set for the line occupied by a stabled load or a goods train in that order so that, in case of mishap, the chance of causalities are minimized [Refer SR.3.51.06 (b)]. In case of all the lines are occupied by Coaching train, points should be set for a loop line to negotiate with the speed of incoming train would be reduced which in turn, would minimize the consequences/causalities.

The above precautions shall be taken in addition to the observance of other precautions [Refer SR 5.04.01 & SR 5.23.01].

6.2.1.2. RECEPTION OF A TRAIN ON BLOCKED LINE:

Trains are to be admitted on a blocked line, by taking off calling-on signal as per GR 5.09(2) (a) or if calling signal cannot be taken off, trains are to be piloted in on a written authority on Form T/509 given by SM on duty and delivered by a competent railway servant to the Loco Pilot of the train as per GR 5.09 (2)(C)(3)(4)(5) and SR 5.09.01.

6.2.1.3. RECEPTION OF TRAIN ON NON-SIGNALLED LINE:

--NIL--

6.2.1.4. DESPATCH OF TRAIN FROM NON-SIGNALLED LINE:

--NIL--

6.2.1.5. DESPATCH OF TRAIN FROM LINE PROVIDED WITH COMMONSTARTER SIGNAL:

--NIL--

6.2.1.6. ANY SPECIAL CONDITIONS:

a) SPECIAL RESTRICTIONS:

--NIL--

b) SPECIAL INSTRUCTIONS:

1. Signal No.S/SH9, S/SH10& SH11 and Stop Signal No.13, 14 & 15 are placed 3M from glued joint as per Railway Board Letter No. (i) 2012/SIG/SEM-II/Misc, dated 10.10.2012, and (ii) 2012/Saftey(A&R)/19/5 dated 13.06.2013.
2. As the CSL of Line No.4 is more than 800M, to avoid the premature release of overlap, overlap release will initiate only when rear portion point zone track circuit is clear and when L4T3 in UP Direction is occupied. Hence SM on duty shall ensure to draw the train ahead for initiation of overlap release.
3. Shunting with the Main Signal is prohibited.
4. No load shall be stabled on Non-isolated Line without live locomotive is attached. Otherwise, vehicles shall be secured as per the Railway Board letter No.2012/Safety (A&R)/19/1 dated 04.12.2018.

6.3. CONDITIONS FOR TAKING “OFF” APPROACH SIGNALS: -

The SM on duty shall nominate a Clear line not only up to the section but also for an adequate distance beyond it for reception of trains. (Refer GR. 3.36, 3.40, 4.17 and SR 3.36.01, 3.36.02, 3.36.04, 3.40.01, 3.40.02, 3.47.01, 4.17.02 and Block Working manual)

6.3.1. RESPONSIBILITY OF STATION MASTER FOR RESTORATION OF SIGNALS TO “ON”:

Station master should ensure that signal is put back to ‘ON’ after passage of the train as per GR 3.36 (2) (b).

6.4. SIMULTANEOUS RECEPTION/DESPACTH, CROSSING AND PRECEDANCE OF TRAINS:

The following simultaneous reception and dispatch facilities are provided at this station.

| | | | |
|----|--|-----|--|
| 1. | Reception of an UP train on Line No.3 setting overlaps Overrun line(UP Loop). | AND | Dispatch of another UP train from Line No.4. |
| 2. | Reception of a DN train on Line No.1 setting overlaps to Overrun Line (DN Loop). | AND | Dispatch of another DN train from Line No.2. |

6.5. COMPLETE ARRIVAL OF TRAINS:

The entire block section between MKRD-PBV&MKRD-BHJA on both UP and DN lines are provided with Single Section Digital Axle Counter.

For Section MKRD-PBV:

A Pair of High Availability Single Section Digital axle counter (HASSDAC) is provided between MKRD-PBV one at just beyond UP advanced starter signal no.25 of MKRD and another on 1T2 track circuit of PBV and another pair of High Availability Single Section Digital Axle Counter (HASSDAC) is provided between PBV-MKRD one at just beyond DN Advanced Starter signal No.26 of PBV and another on 1T2Track circuit of MKRD for last vehicle verification.

For Section MKRD-BHJA:

A Pair of High Availability Single Section Digital axle counter (HASSDAC) is provided between MKRD-BHJA one at just beyond DN advanced starter signal no.26 of MKRD and another on 1T2 track circuit of BHJA and another pair of High Availability Single Section Digital Axle Counter (HASSDAC) is provided

between BHJA-MKRD one at just beyond UP Advanced Starter signal No.25 of BHJA and another on 1T2Track circuit of MKRD for last vehicle verification.

The position of the Block section whether cleared or occupied is reflected in the axle counter reset box and VDU provided in the Station Master's office which shows `GREEN' when the Block Section is clear and `RED' when occupied. Whenever a train enters in to the Block Section, "Block Section Clear" indication 'GREEN' for the particular block section disappears and 'RED' indication appears.

After complete arrival of the train the `RED' indication will disappear and 'GREEN' indication will appear. If after the complete arrival of the train the 'RED' indication does not change to 'GREEN' it should be assumed as Block Instrument failure for the particular section and necessary action as per GR.14.13 is to be followed. The axle counters are interlocked with the respective block instruments for that section. If axle counter fails, Advanced Starter signal and IB Home Signals as the case may be cannot be taken off for next train and the concerned instrument shall remain locked in last operated position.

A resetting arrangement is provided in the SM office to reset the system to normal position in case of failure of both the systems of Axle counter for HASSDAC. The resetting to be initiated by the SM at the receiving station only after physical verification of complete arrival of train by exchanging private number. The resetting can be accomplished only with the co-operation of SMS at either end of the block section. Details of resetting procedure is given in Appendix-'B'

Note:

Before taking off reception and dispatch signals for UP or down directions the SM on duty should ensure that the entire route including overlap and berthing portion is clear of all obstructions by observing the Track indication/Axle counter indication.

6.6. DESPATCH OF TRAINS:

- a) Dispatch of trains is governed by the provisions of GR. 3.42 and SRs 3.36.04(b), 3.42.04; 3.42.01(a) and BWM 3.07(5)(a), (e), (f) & (g) and other relevant provisions of G & SR, BWM and SWR.

b) **DESPATCH OF TRAINS FROM NON-SIGNALLED LINE:**

Dispatch of trains from non-signalled line is governed by the provision of GR 5.11 and SR 5.11.01.

c) **ISSUE OF CAUTION ORDERS:**

Whenever in consequence of the line being under repairs or for any other reasons special precautions are necessary a Caution Order detailing the Kilometres and Speed at which train should run with reasons for taking such precautions shall be handed over to the Guard and Loco Pilot in terms of GR 4.09 and SR thereto.

6.7. TRAINS RUNNING THROUGH:

In addition to the procedure detailed in paras "Reception and Dispatch of trains" rules laid down in GR 3.40, 4.17, 4.42 with relevant SRs 3.42.02 (a) (iii) and other relevant provisions of G&SR, BWM, OM shall be followed. (Refer GR 4.1, 4.11(2)).

6.8. WORKING IN CASE OF FAILURE:

| | |
|---|---|
| <i>Track Circuits</i> | In case of failure of track circuits, the clearance of the concerned line should be ensured physically by the SM on duty before a train is piloted. |
| <i>Axle Counters</i> | If the axle counter fails between the block sections, resetting procedure should be adopted as per Para 6.1 of SWR (APP-B). If the axle counter for Bridge No.487 fails resetting procedure should be adopted as per Para No.6.2 of SWR (APP-B). If the axle counter indication does not appear 'GREEN & continues to show 'RED' condition after resetting, the concerned block section shall be suspended & failure intimation to be given to sectional signal Maintainer /JE/SE (signal) for their rectification. |
| <i>Block Instruments</i> | In the event of failure of block instrument, the concerned block instrument shall be suspended till its rectification and trains shall work as per GR (Refer SR 6.02.03 & 6.02.06). |
| <i>Reception of a train on obstructed line</i> | Trains are to be admitted on a blocked line, by taking off calling-on signal as per GR 5.09(2)(a) or if calling signal cannot be taken off, trains are to be piloted as per GR 5.09(2)(C)(3)(4) (5) and SR 5.09.01. |
| <i>Reception of a train on non-signalled line</i> | NIL |
| <i>Defective Signals</i> | Whenever signals become defective, the procedure laid down in GR 3.68 to 3.71, 3.80 and SR 3.68.01 (c) shall be followed. In case of disconnection of signal and interlocking for repairs and maintenance procedure laid down in GR and relevant SRs shall be followed. In the event of signal showing no lights, station master on duty shall before giving line clear initiate action in accordance with the procedure laid down in GR and the relevant SRs (Refer 3.57, 3.69, 3.49 (4), 3.68 to 3.77). |
| <i>Defective Interlocking</i> | When interlocking becomes defective the SM on duty shall be responsible for correct setting, clamping, padlocking of points for admission of train. [Refer SR 3.69.03 (c) & 3.69.01]. |
| <i>Defective/Damaged Points</i> | When any point fails to operate normally by the route setting operation or individually through VDU it is inevitable to operate the points with crank handle. The SM on duty shall personally ensure clamping and padlocking of all facing and trailing points on the Route. Crank handles are interlocked with signals and interlocking system. When points become defective, the signals controlling these points shall be considered defective and vice-versa and the procedure for the use of crank handle. |

6.9. PROVISIONS FOR WORKING OF TROLLIES/ MOTOR TROLLIES/MATERIAL LORRIES ETC”:

- a) The section where Axle Counters are provided in Lieu of track Circuits, trolleys, Motor trolleys, Lorries etc., which are not insulated shall not be allowed to run except on Line clear.

- b) Motor trolleys shall be worked as per GR 15.25 and SR thereto, BWM 5.39, 5.40, 5.41, 6.11(1)(2), 6.12, 6.13, 6.14(2)(a) and circulars and orders issued from time to time.
- c) Material Lorries shall be worked as per GR 15.27 and SRs thereto and in accordance with the provisions of Block Working Manual.
- d) Tower Wagon/OHE cars shall be worked as per GR 17.08 and SR thereto and BWM 4.39.

(7) BLOCKING OF THE LINES:

Whenever a running line is blocked either by loose vehicles or by stabling train or by a train which is to cross or give precedence to another train, the points at either end should immediately be set against the blocked line except during shunting movement. 'Line Block' is to be activated on VDU by SM on duty following procedure laid in para-No.5.4.1 & 5.4.2 of Appendix-B. A clear remark in 'RED' ink shall be made immediately in the train signal register and a record shall be made in the Station Master's diary also. Stable load register is also to be maintained. The stable load or loose vehicles are to be secured to prevent rolling down of vehicles. [GR 5.23 and SR 5.23.01]

(8) SHUNTING:

8.1. GENERAL PRECAUTIONS:

The rules laid down in GR 3.46, 3.52 to 3.56, 5.13,5.14,5.16 to 5.23, 8.05,8.06, 8.14 and 8.15 with relevant SR's and OM 7.01, 7.07, 7.08, 5.15 (1) (B) and 5.1 (2) (B) shall be followed.

All shunt movements shall be supervised by Guard/SM on duty or by a competent Railway servant deputed by SM on duty as the case may be. The authority for shunting shall be the taken off of shunt Signaler on form T/806 whichever is applicable. The limit up to which shunting is permitted and the line involved must write on the shunting authority.

8.2. SHUNTING IN FACE OF AN APPROACHING TRAIN:

Shunting in face of an approaching train is prohibited on both ends vide GR 8.09.02 (ii) (a).

8.3. PROHIBITION OF SHUNTING, SPECIAL FEATURES IF ANY:

- i) Hand shunting is prohibited at both ends of the yard vide GR 5.20.
- ii) Fly shunting is prohibited at both ends of the yard vide SR 5.21.01 (c).

8.4. SHUNTING ON SINGLE LINE:

Not Applicable

8.5. SHUNTING ON DOUBLE LINE:

| | | |
|----|---|---|
| a) | <i>Block back</i> | The procedure of Block Back given in BWM 5.15 (1) (b) shall be followed |
| b) | <i>Block Forward</i> | GR 8.05 and SRs there to shall be followed. |
| c) | <i>During failure of Block Instrument</i> | Shunting in the block section in advance/in rear shall not be performed unless the section is clear of all obstructions and the block section is Blocked back/Blocked forward as the case may be. SM shall fix the line block collars on respective Block Instrument. |

8.6. SHUNTING IN THE SIDING TAKING OFF FROM THE STATION YARD:

--NIL--

(9) ABNORMAL CONDITION: -**a) RULES TO BE OBSERVED IN THE EVENT OF ABNORMAL CONDITIONS:**

- i) During partial interruption/failure of electrical communication instruments SR 6.02.06 shall be followed.
- ii) The authority to proceed in the occupied block section in case of obstruction of line or accident etc is T/A-602 and SR 6.02.05 shall be followed.
- iii) Trains delayed in the block section: GR 6.04 and relevant SRs shall be followed.
- iv) Failure/ passing of IBS signed in ON position: NIL.
- v) Failure of Axle Counter Block/BPAC: As per Appendix-'B'.
- vi) Failure of MTRC: NIL.

b) PROCEDURE FOR EMERGENCY OPERATION OF POINTS BY CRANK HANDLE: -

- (i) The detailed Procedure for emergency operation of points by Crank Handle of motor operated points is mentioned in Para No.5.3, 5.3.1 and 5.3.2 of Appendix-'B' of this SWR.

On account of the doubtful operation of any track circuit by a light vehicle including self-propelled vehicle such as Motor trolley or light Diesel/electrical engine or tower wagon, indicating the occupancy of the track. It is necessary that SM on duty satisfies himself that the said vehicle has cleared point zone track circuits by observing the track indications of the track on either side of the cross over by positively checking the entrance and exit track circuits are showing occupancy and clearance in accordance with the train movement.

(ii) PROCEDURE FOR EMERGENCY OPERATION OF POINTS WITH POINT ZONE TRACK CIRCUIT/AXLE COUNTER FAILURE AND EMERGENCY ROUTE RELEASE:

The detailed Procedure for emergency operation of points in case of failure of Point Zone track section is mentioned in Para No.5.2, 5.2.1 and 5.2.2 of Appendix-'B' of this SWR.

Rules regarding locking of points and damaged points vide GR 3.39 and GR 3.77 to be followed.

c) CERTIFICATION OF CLEARANCE OF TRACK BEFORE CALLING-ON SIGNAL OPERATION IS INITIATED: -

Before taking off Calling -on signal during failure of track circuit/axle Counter, the route and the clearance of the track over which train would pass to be verified by SM on duty.

d) REPORTING OF FAILURE OF POINTS, TRACK CIRCUITS/AXLE COUNTER AND INTERLOCKING: -

- (i) Whenever there is a failure of points, Track circuits/axle counter or any interlocking gear at station, the failure should be reported by SM on duty to the concerned Signaling Maintenance Staff on duty responsible for attending to the failure and only after receipt of the written memo from the Signaling Maintainer for rectification of the fault, SM should restore the normal working.

- (ii) The entries in failure register to be done with message to the section controller.

9.1. TOTAL FAILURE OF COMMUNICATION:

- a) In the event of total failure of communication on double line, trains shall run on the authority to proceed without line clear in terms of SR 6.02.03.
- b) During partial interruption of communication, the rules laid in SR 6.02.06 shall be followed.

9.2. TEMPORARY SINGLE LINE WORKING ON DOUBLE LINE SECTION:

In the event Single line working on double line section when one line is obstructed the trains shall work as per the provision laid down in SR 6.02.01.

9.3. DESPATCH OF TRAINS UNDER AUTHORITY TO PROCEED WITHOUT LINE CLEAR OR TO ASSIST THE CRIPPLED TRAIN:

- i). In the event of total failure of communication, trains shall run on the authority to proceed without line clear in terms of SR 6.02.03.
- ii). In the event of necessity to send a train to assist the crippled trains, SR 6.02.05 shall be followed.

(10) VISIBILITY TEST OBJECT:

The signals lights of UPStop Signal No.15and DN Starter Signal No.10of Line No.1 are earmarked to serve as visibility test object during day and night vide GR 3.61 (2) (b) (iii).

(11) ESSENTIAL EQUIPMENT AT THE STATION:

Details are given in Appendix-E.

(12) FOG SIGNAL MEN NOMINATED TO BE CALLED IN CASE OF FOG:

- (i) During thick, foggy or tempestuous weather impairing visibility of the Signals the SM on duty shall initiate action to depute Fog signal man with detonators vide GR 3.61 in order to indicate the location of the station approach signals to the Loco pilot of an approaching train.
- (ii) The fog signal man shall be proceeding to the 1st stop signal of the station and place one detonator at a distance of 270M from the 1st approaching stop signal towards the approaching train and another detonator at a distance of 10M from the 1st one and he shall stand 45M away from the detonator.
- (iii) The fog signal man shall be permanent employee, no temporary or casual labour shall be deployed as fog signal man.
- (iv) The assurance of fog signal man available at the station (including engineering branch if available) shall be obtained in the fog signal register every year in the month of "OCTOBER".
- (v) Details of supply of detonators available stock, use and testing etc., shall be maintained in the fog signal register of the station as per GR 3.64 and SRs there to.

Note: Names of fog signal man available at the station shall be exhibited in SM's office.

LIST OF APPENDICES:

- APPENDIX-A : WORKING OF LEVEL CROSSING GATES
- APPENDIX-B : SYSTEM OF SIGNALLING AND INTERLOCKING AND COMMUNICATION ARRANGEMENTS AT THE STATION.
- APPENDIX-C : ANTI COLLISION DEVICE (RAKSHA KAVACH)
- APPENDIX-D : DUTIES OF TRAIN PASSING STAFF AND STAFF IN EACH SHIFT.
- APPENDIX-E : LIST OF ESSENTIAL EQUIPMENT PROVIDED AT THE STATION.
- APPENDIX-F : RULES FOR WORKING OF DK STATIONS, HALTS, IBH, IBS AND OUTLYING SIDINGS.
- APPENDIX-G : RULES FOR WORKING OF TRAINS IN ELECTRIFIED SECTIONS.



APPENDIX 'A'

WORKING OF LEVEL CROSSING GATES AT MACHKUND ROADSTATION

---NIL---

APPENDIX 'B'
SYSTEM OF SIGNALLING & INTERLOCKING AND COMMUNICATION
ARRANGEMENT AT THE STATION

(Detail description of signalling and interlocking installations, instructions for working them normally and in emergencies etc. including power supply arrangements).

1. BRIEF DESCRIPTION OF THE SIGNALLING AND INTERLOCKING INSTALLATIONS:

MACHKUND ROAD is a Class 'B' station provided with Standard-II (R) Electronic Interlocking of M/s. Medha Servo India Pvt Ltd., make. The station is provided with Route setting type Electronic Interlocking between points, signals, track circuits and other signaling gears. The station is equipped with Multiple Aspect Colour Light Signaling. All points and signals are power operated through a central **Visual Display unit (VDU)** installed in the SM's Office.

2. DESCRIPTION OF OPERATOR CONSOLE CUM VISUAL DISPLAY UNIT (VDU):

The Operator Console cum Visual Display Unit (VDU) in dual configuration is provided for operation of Signals, points, Crank handles and controls etc. A mimic yard diagram based on SI plan No. SI/23211 ALT-'B' with Special Note-S1 shall be displayed on the VDU. The VDU is used for controlling and monitoring the station. Indications on the station mimic diagram of VDU will be dynamically updated.

3. SYSTEM OVERVIEW

The PC-based **Operator VDU** for the operation of Signals, Points, Crank Handles and Siding Controls, etc. The SM of a station required to be familiar on the specific station's SWR (station working rules).

Operator VDUs consist of CPU with a color monitor, keyboard and pointing device (mouse). Through communication media the exchange of control and indication messages takes place with operator VDU. The Software is installed to display the Station Yard Mimic diagram on the operator VDU and it allows access to all functions by selecting menus with a click of mouse on the corresponding function icon. By selecting the menu, the function (Signal clear and cancellation, Route release, point operation etc.,) can be executed.

The operator VDU is used for controlling and monitoring the station. However, indications on the Station yard mimic diagram of operator VDU will be dynamically updated.

3.1. DUAL VDUs - MODE OF SELECTION:

The privilege has been given to the operator for controlling the station through VDU-1 or VDU-2. With Dual VDU concept, we can control either from A-VDU or B-VDU by selection through switch provided on the SM's table.

The operator VDU is having controls to operate the field gears through the Mimic diagram. A Mimic panel diagram displayed on the operator VDU is an exact replica of yard that suits SI plan.

4. CONTROL(S) & INDICATION(S):

4.1. ICONS AND INDICATIONS PROVIDED ON THE VDU:

In addition to mimic yard diagram including signal, points, track circuit, Axle counters, sidings as indicated in the WRD, various other ICONS and indications

APPENDIX-'B'

have been provided on the VDU. A brief description of the same are described below.

| SN | ICONS | INDICATIONS | FUNCTIONS | REMARKS |
|----|--|--|--|---|
| 1. | PC SM KEY | Green Colour when key is 'IN' | Ensures operation of VDU by authorized person | Protected by pass word |
| 2. | --- | Emergency Route release - UP & DN | Flashing indication appears when Emergency route release operation is initiated. | For each operation concerned counter shall register one count higher. |
| 3. | Emergency Point operation key | Green light when key is 'IN'. Yellow light indication appears showing request for Emergency point operation is acknowledged. | Ensures emergency point operation by authorized person | Protected by Pass word. For each operation concerned counter shall register one count higher. |
| 4. | Point failure Ack. button | Red | Flashing indication appears when any point fails. SM has to left click on the icon to acknowledge. | Buzzer will sound. On acknowledgement, buzzer stops. After verification at site inform S&T staff immediately if failure persists. |
| 5. | Signal failure Ack. button | Red | Flashing indication appears when any signal fails. SM has to left click on the icon to acknowledge. | Buzzer will sound. On acknowledgement, buzzer stops. Inform S&T staff immediately if failure persists. |
| 6. | CH-1, CH-2, CH-3, CH-4, -----, buttons | Yellow lamp indicates 'KEY IN'. Red lamp indicates 'CH LOCKED' | In normal condition yellow lamp will be lit. Whenever the crank handle is locked in route or otherwise red indication will glow. | |
| 7. | SDG CNT-37, SDG CNT-41 buttons | Yellow lamp indicates 'KEY IN'. Red lamp indicates 'SDG KEY LOCKED' | In normal condition yellow lamp will be lit. Whenever the Siding Control key is locked in route or otherwise red indication will glow. | |

APPENDIX-'B'

| SN | ICONS | INDICATIONS | FUNCTIONS | REMARKS |
|-----|---|------------------------------------|--|---|
| 8. | 'DN Train Entering Section' muting button | Yellow acknowledged | On getting alarm/buzzer SM shall left click on the button icon to acknowledge it. | |
| 9. | 'UP Train Entering Section' muting button | Yellow acknowledged | On getting alarm/buzzer SM shall left click on the button icon to acknowledge it. | |
| 10. | UP Block Release button | Yellow Prepared for Block release. | On getting indication SM shall left click on the button icon which shall release Block Handle. | After complete arrival of train this will be activated |
| 11. | DN Block Release button | Yellow Prepared for Block release. | On getting indication SM shall left click on the button icon which shall release Block Handle. | After complete arrival of train this will be activated |
| 12. | Line Block button | Red when blocked | SS/SM shall point the cursor on the icons provided on the berthing track and right click. One drop menu will appear indicating line blocked and un-blocked, SS/SM has to select the required menu. | When line block is selected the concerned button on the particular line turns to RED. |

4.2. PC SM KEY:

SM key is physically provided on VDU change over panel, outside the VDU on SM's Table. This key when inserted in the lock [provided on VDU change over panel] and turned right the VDU becomes operative. The key when inserted in the lock and either turned to left or extracted out from the lock renders the VDU inoperative except for putting back the signals to 'ON' position in case of emergencies. When SM's key is inserted and turned to right a red indication lit above the SM's Key icon on the VDU.

PC Control:

If any one of VDU has shut down for maintenance or in case of failure, after resumed to normal working or rectification, for getting the operations from the VDU, first enable the PC which is virtual SM's Key. To enable the PC, right click on the PC icon which activates the PC enable option.

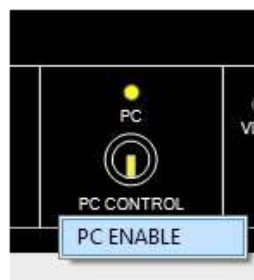

APPENDIX-'B'

Then click on the PC enable option which will enable the password window to appear. After the valid entry of user name and password, the PC will be enabled. The user name is ECoR and the password of this station is MKRD.



4.3. ELECTRONIC INTERLOCKING (E.I) SYSTEM INDICATIONS:

a) Vital Interlocking Computer Status:

In EI, two Vital Interlocking Computer cards are available normally. The status of each of the VIC is provided on VDU as following.

VIC - A Indications



VIC-A is Active



VIC-A is Stand By



VIC-A is Not Available

VIC -B Indications



VIC-B is Active



VIC-B is Stand by



VIC-B is Not Available

If there is any change in VIC's status, its current status will be displayed along with OK button and a buzzer is turned on to alert the operator. The Buzzer stops and the indication message disappear when the OK button is pressed by the Operator.



Action by SM: If at least one VIC is available and is in Active State, then EI shall continue to function. On observing this fault, SM shall acknowledge the fault and immediately inform Signal Maintainer for further action.

b) Link Status Indication:

APPENDIX-'B'

The EI VDU receives the data from EI Equipment through two OFC channels. The Link Status Indication of the same is provided on the VDU.

When Channel - A or Channel - B link is healthy, corresponding Yellow indication will be glowing steadily. When Channel - A or Channel - B link is faulty, corresponding red indication will be shown steady.



Channel -A Link Status is Healthy



Channel - A Link Status is Faulty



Channel - B Link Status is Healthy



Channel - B Link Status is Faulty

Buzzer and Acknowledgment:

When Channel A link or Channel B Link fails, a Buzzer is turned on automatically to alert the operator. To acknowledge the fault, right click on this control, a pop- up menu is displayed and then click on the Ack menu option. The Buzzer stops when the fault is acknowledged by the Operator.



When any of the channelslink fail, an indication is shown in red color.

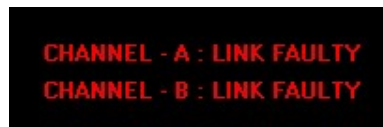

When any of the links is recovered, the indication is shown in yellow color along with one OK button. The indication message disappears if OK button is pressed.



Action by SM: If at least one of the Communication Channels is Healthy, EI VDU shall continue to function as usual emanating all indications. On observing

APPENDIX-'B'

any communication channel faulty indication, SM shall acknowledge the fault and immediately inform the Signal Maintainer.

c) EI Equipment Critical Fault:

If EI is shut down due to any critical fault, a message is displayed in red color along with OK button and a buzzer is turned on to alert the operator. The Buzzer stops and the indication message disappear when the Operator presses the OK button.

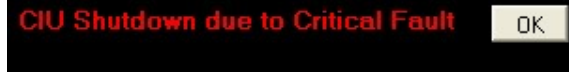

Action by SM: SM shall acknowledge the fault, inform the Signal Maintainer.

4.4. VDU ACTIVE INDICATIONS:

Whenever the VDU is in active condition a RBG sequence will be running in the top right corner of the screen. That is in a flashing sequence in the screen.

4.5. OPERATION AND INDICATION OF POINT:

To Operate the Point the SM needs to track the mouse pointer to concerned Point on the VDU, after clicking by the right button of the mouse a popup menu will appear as shown below.

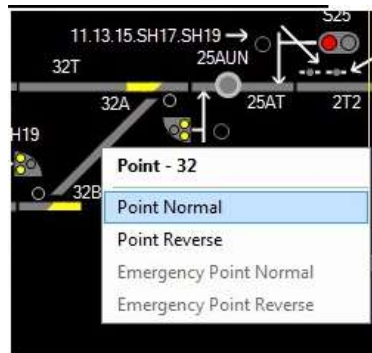

4.5.1. REVERSE TO NORMAL OPERATION:

To operate the point from reverse to normal after clicking on the concerned point Track the pointer to **POINTNORMAL** in the popup menu and click, a Normal flashing indication will appear, the indication will be steady after the point is set to Normal.

4.5.2. NORMAL TO REVERSE OPERATION:

To operate the point from normal to reverse after clicking on the concerned point Track the pointer to **POINT REVERSE** menu and click, a Reverse flashing indication will appear, the indication will be steady after the point is set to Reverse.

4.5.3. POINT INDICATIONS:

When the point is free a steady yellow strip of light will appear either in the normal portion of point zone (In case of cross over at both ends) or in the reverse portion of point zone depending up on the position of point, indicating that the point is set. When the point is operated from the normal to reverse the strip of light in the normal portion is disappears and starts flashing in the

APPENDIX-'B'

reverse portion and becomes steady when the point is set and detected. Similarly, when the point is operated from the reverse to normal the strip of light in the reverse portion disappears and starts flashing in the normal portion and becomes steady when the point is set and detected. When the point is engaged in a route, a yellow indication will appear near the point and red indication appears in the point lock indication showing that the point is locked and cannot be operated.

4.6. SIGNAL OPERATION:

To Take-Off a Signal with the desired route the SM needs to track the mouse pointer over the concerned Signal on the VDU, after clicking right mouse button a pop-up menu will appear as shown below for route set, signal cancellation and route release operations.

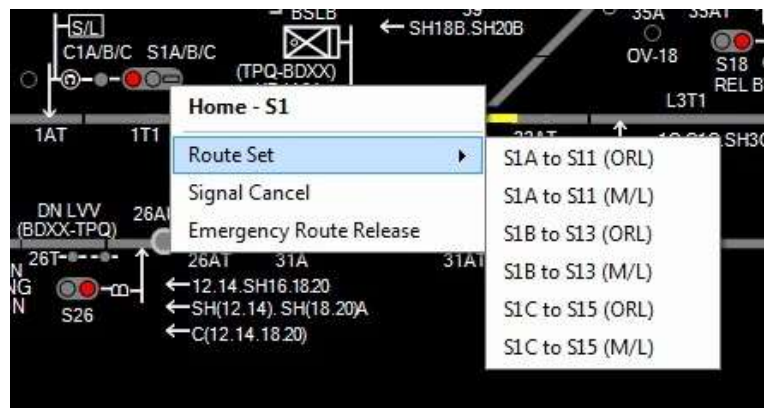

4.6.1. SETTING A ROUTE:

To set a route of a signal, track the mouse on the 'Route Set' Sub menu which shows all the possible routes of the signal, then track the mouse on desire route and click the left mouse button. After doing, so a RED colour route initiation indication will be flashing appears on the replacement track of the signal and all the Normal/Reverse set indication of the Points in the route will start flashing if it is not available in required position. After setting of points in the route, overlap and isolation in required condition flashing indication will become steady and a complete yellow 'Route set' indication will appear over the route right from replacement track of the signal to the last track of overlap section of the route. Also, the point lock indication will appear through Red indication near the point. Finally, a route locked yellow steady indication will appear immediate to rear of the signal. Now the signal will be taken-off. The yellow route set indication will turn to red when the train occupies the concerned track circuit.



Conditions for setting a route:

APPENDIX-'B'

The following condition to be ensured before setting the route by the SM/ ASM.

1. All the points in the route, overlap and isolation are set and locked in the required position.
2. All the Crank handles of the required route related points to be in Key-IN condition.
3. All the related Siding control keys if any are to be in Key-IN condition.
4. If any Level Crossing gates are falling under the route that should be closed and locked (KEY IN).

4.6.2. SHUNT SIGNAL OPERATION:

For setting the signal route for the shunt signal the same procedure shall be followed as explained in section for Main signal operation. To Take-Off a Shunt Signal with the desired route the SM needs to track the mouse pointer over the concerned shunt Signal on the VDU, after clicking right mouse button a pop-up menu will appear as shown in the Main Signal operation for route set signal cancellation and route release operations. Track the mouse on the 'Route set' sub menu which displays all the possible routes of the Shunt Signal and track the mouse on the desired route and click the left mouse button. After doing so, desired route will be initiated and the Shunt Signal will be taken off.

**4.6.3. CALLING ON SIGNAL OPERATION:**

Calling-on signal route set operation is similar to the same procedure as mentioned for the main signal. For calling-on Signal, route is set after a train occupies the approach track circuit in immediate rear of the stop signal. The calling on Signal is cleared after a lapse of 60 Seconds provided other conditions are fulfilled.

To take "OFF" Calling-on signal the train must come to a stop at the foot of the Home signal, occupying the track circuit (1AT & 2AT as the case may be) in rear of the signal. When a train occupies the track circuit a RED-light strip will appear on the VDU. The particular route on which train is intended to be received shall be set by tracking the pointer in VDU on to the signal below which the calling on signal is provided. Right click on the calling-on Signal which will appear a pop-up menu as follows.

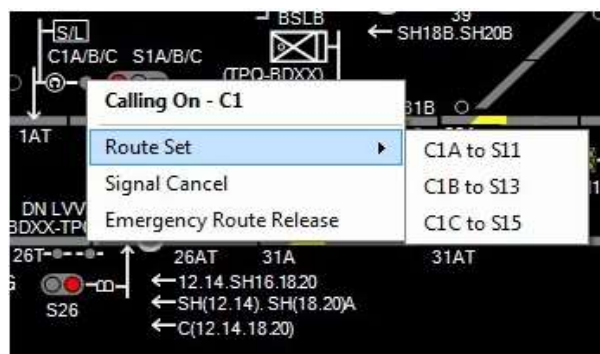

APPENDIX-'B'

Then the SM must drag the pointer and click over the 'Route set' sub menu which displays all possible routes and track the mouse on required route and click the left mouse button as a result of which the calling-on signal will blink for 60 seconds for all home signals the time delay is 60 seconds, the Calling-on signal clears i.e. a yellow light glows at the concerned calling-on signal on the VDU.

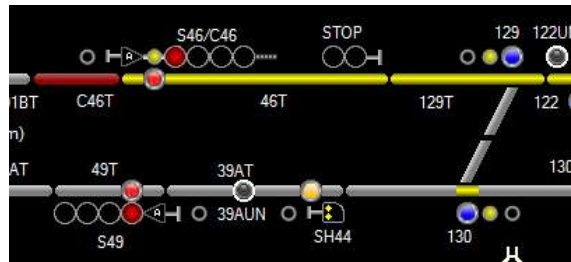

This action will be recorded in a respective counter of the counter box provided on SM's table. Every such operation shall be recorded by the SS/SM on duty along with the reasons to do so. The calling-on signal route can be released after complete arrival of the train by Signal cancellation only.

4.7. CRANK HANDLE CONTROL OPERATION:

Normally a 'KEY IN' (Yellow) indication will appear on the VDU indicating that the Crank Handle is free. To Transmit or Release control of the Crank Handle, right click on the crank handle control button provided like the following button on the VDU.



The appearing pop-up menu gives details of the possible commands on the Crank Handle.

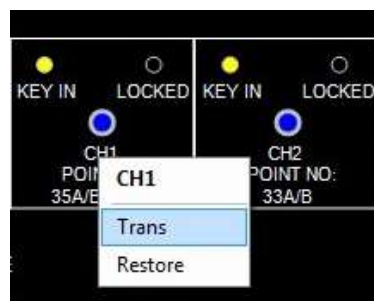

For Transmitting the Crank Handle KEY to the field personnel, SM has to transmit the control by clicking **TRANS** on menu of the Crank Handle Button. After transmission, the KEY IN indication will start flashing; now the KEY can be extracted from the EKT. After extracting the key from the EKT, the key IN indication will disappear. This action will be recorded in a respective counter of the counter box provided on SM's table. The counter will increment the number for each and every such action and also, this number should be recorded by the

APPENDIX-'B'

SM on duty who shall record the details of the Crank Handle operation along with the latest counter number in a register.

When the Manual point operation is completed, after putting the KEY back in the EKT, corresponding Crank Handle KEY IN flashing indication will appear on the VDU. Now the operator has to Release the control for the steady indication, for that right click on the Crank Handle and select the **RESTORE** in the menu appeared.

A Crank handle locked indication (Red) will appear, when the particular point is locked through the signal route set over it or engaged on route setting in any other way.

4.8. SIDING CONTROL OPERATION:

Normally a 'KEY IN' (Yellow) indication will appear on the VDU indicating that the Siding point is free to operate. To Transmit or Release control of the Siding point, right click on the concerned Siding control button on the VDU.



The appearing pop-up menu gives details of the possible commands on the Siding control button.

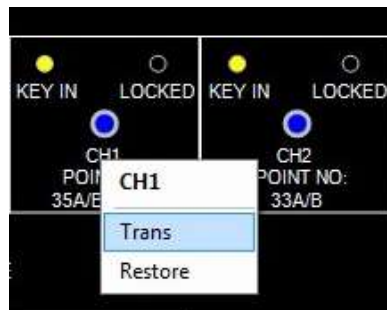

For Transmitting the Siding control KEY to the field personnel, SM has to transmit the control by clicking **TRANS** on menu of the Siding point Button icon. After transmission, the KEY IN indication will start flashing; now the KEY can be extracted from the EKT. After extracting the key from the EKT, the key IN indication will disappear. This action will be recorded in a respective counter of the counter box provided on SM's table. The counter will increment the number for each and every such action and also, this number should be recorded by the SM on duty who shall record the details of the Siding point operation along with the latest counter number in a register.

When the Electrical operation of point from site is completed (detailed procedure for electrical operation from site is given in the Para No.18 of this appendix), after putting the KEY back in the EKT, corresponding Siding control KEY IN flashing indication will appear on the VDU. Now the operator has to Release the control for the steady indication, for that click on the Siding control and select the **RESOTRE** in the menu appeared.

APPENDIX-'B'

A Siding control locked indication (Red) will appear, when the particular point is locked through the signal route set over it or engaged on route setting in any other way.

4.9. OVERLAP TIME RELEASE:

A separate indication for each overlap is provided near the starter signal to indicate the free or locked condition of overlap. This indication light will glow when overlap is locked by any Home Signal route and there will be no light when overlap is free. The locked indication starts flashing when the approaching train clears the rear end point zone track and occupies the berthing track. After a time, release of 120 seconds the white flashing light will disappear indicating concerned overlap is free.

5. EMERGENCY OPERATIONS:

To carry out different emergency operations the following procedures are to be followed.

5.1. CANCELLING A ROUTE/ EMERGENCY ROUTE RELEASE:

To cancel a signal route when the route is set and the signal is taken-off, click on the signal cancellation option on the menu (Main/Calling on) of the concerned signal, the signal will immediately go to ON aspect.

The precondition for route release is, the route should have been set and the signal has been put back to danger. If you wish to cancel the route, select the desired signal and click the right mouse button on it. The system would display a popup menu with a list of commands near the control symbol. Select the "Route Release" from the menu list.

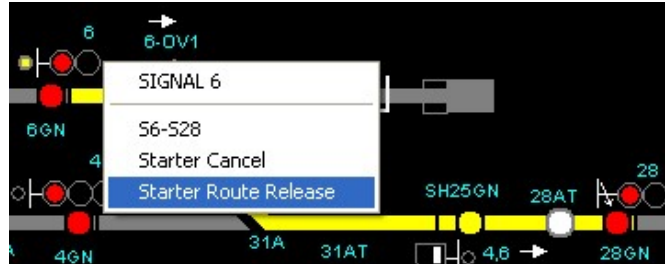

Since all the Signals at this station are having Dead Approach, A flashing indication on the route lock indication near the control symbol and in the emergency route release indication block UP/DN SIDE indication will appear as shown in the figure below indicating that the route release is in progress. After 120sec the flashing indication stops, UP/DN SIDE indication will disappear and then whole route would be released.



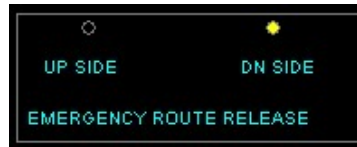

Counter provided on Counter Box for the route release will change to next higher digit. This number should be recorded by the SM on duty who shall record the details of the Route cancellation along with the latest counter number in a register.

5.2. EMERGENCY POINT OPERATION:

When the point zone track circuits failed without any point lock condition through respective signal route(s), a point can be operated by the Emergency Point operation.

Note: Before resorting to this operation SM on duty shall verify that the point zone is clear of any vehicle occupying the track section and the same is clear of any obstruction.

Before doing the emergency operation, SM on duty shall enable the Emergency Point Operation Key. To 'KEY IN' the Emergency Point Operation the on-duty SM, by right click on Emergency point operation Key Icon, a pop up menu will appear as follows.

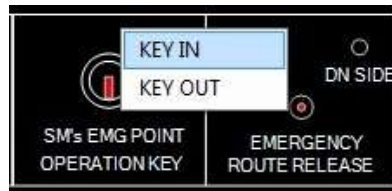

Click on the KEY IN in the menu appeared and shall provide User Name and Password for the same as follows.



Enter the assigned username and password and click "Ok". The system would validate the user inputs and show the "KEYIN" indication, if the validation is successful.

The username of this station is 'ECOR' and password of this station is MKRD. Then point operation can be done to either normal or reverse as per requirement.

5.2.1. EMERGENCY NORMAL OPERATION:

APPENDIX-'B'

Track the pointer to the corresponding Point which is intended to operate and then right click the mouse button. After doing so, a pop-up menu will appear as shown below.

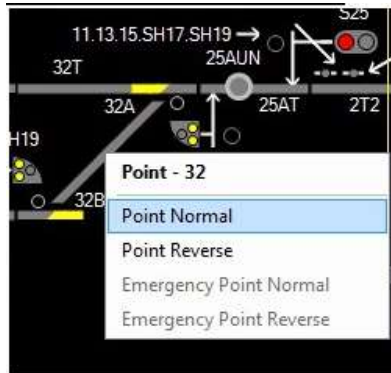

Then track the pointer on the '**EMERGENCY POINT NORMAL**' and click left mouse button, after doing so point gets operated and Normal flashing indication will appear, the indication will be steady after the point is set to Normal.

After the Emergency point operation, a specific counter will change to its next higher digit and this number should be recorded in the register provided for this purpose by the SM on duty who shall record the details of the Emergency Point Operation along with the latest counter number in a register.

5.2.2. **EMERGENCY REVERSE OPERATION:**

Track the pointer to the corresponding Point which is intended to operate and then right click the mouse button. After doing so, a pop-up menu will appear as shown above. Then track the pointer on the '**EMERGENCY POINT REVERSE**' and click left mouse button, after doing so point gets operated and Reverse flashing indication will appear, the indication will be steady after the point is set to Reverse.

After the Emergency point operation, a specific counter will change to its next higher digit and this number should be recorded in the register provided for this purpose by the SM/ASM on duty who shall record the details of the Emergency Point Operation along with the latest counter number in a register.

After the completion of the Emergency point operation, the Key to be switched over to 'KEY OUT'. Same procedure as mentioned for KEY IN shall be followed for KEY OUT also. To make Emergency Point KEY OUT, click on the "**Emergency Point Operation KEY**" symbol; the system would display a pop menu as shown in figure in the Para No.5.2 above. Click on the KEY OUT in the menu appeared and shall provide User name and password. The username of this station is 'ECOR' and password of this Station is 'MKRD'.

***Note:** The Emergency Point Normal and Emergency Point Reverse options are normally in disabled mode. These are enabled only when the Emergency Key is in KEY-IN position.*

5.3. **EMERGENCY CRANK HANDLE RELEASE OPERATION:**

When a crank handle is locked due to earlier set route is not released or otherwise. To Transmit or Release control of the Crank Handle, SM on duty shall cancel the relevant signal first and then track the pointer on the crank handle control button icon provided like the following on the VDU and click the right

APPENDIX-'B'

mouse button. On clicking, the pop-up menu gives details of the possible commands on the Crank Handle.

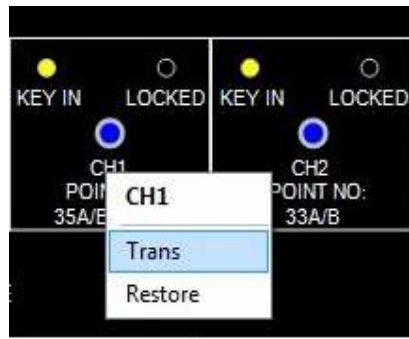

For Transmitting the Crank Handle KEY to the field personnel SM on duty has to track the pointer on '**TRANS**' menu and click the left mouse button. After transmission the 'KEY LOCKED' (Red) indication will start to flash for 120 seconds & 'KEY IN' remains steady. After this the 'KEY LOCKED' indication will vanish & 'KEY IN' indication will start to flash. After extracting the key from the RKT, the 'KEY IN' indication will disappear. When the Manual point operation is over, after putting the crank handle key in the RKT, flashing 'KEY IN' indication will appear on the VDU, now the SS/SM on duty shall Release the control for the Steady indication by clicking '**RESTORE**' menu.

This action will be recorded in a respective counter of the counter box provided on SM's table. The counter will increment the number for each and every such action and also, this number should be recorded by the SM on duty who shall record the details of the Emergency Crank Handle Operation along with the latest counter number in a register.

5.3.1. EMERGENCY CRANK HANDLE RELEASE DURING FAILURE OF BOTH THE VDUS (ACTIVE & STAND BY):

When both the VDUs (Active & Stand by) provided for operation of signals & points in EI station cease to work at the same time due to power failure or what so ever the reason, the SM on duty shall put the VDU Switch to middle position (i.e No VDU) and turn the key (ECH) to right provided in the key box fixed on the SM table. By resorting to this, timer is initiated and after 120 seconds all the crank handles are released at a time. This will be indicated by the indicator provided on the SM Key box. The SM on duty can set the required point/points through crank handles manually by extracting the key/keys from EKTs provided in the location boxes.

| CRANK HANDLE CONTROLS FOR EMERGENCY OPERATION OF POINTS | | | |
|---|--------------|----------------|-----------------------|
| S No | CRANK HANDLE | CONTROL POINTS | PROVIDED IN |
| 1. | CH1 | 35A/B | UP CH LOC-1, BHJA End |
| 2. | CH2 | 32A/B | DN CH LOC-1, PBV End |
| 3. | CH3 | 33A/B | UP CH LOC-2, BHJA End |
| 4. | CH4 | 34A/B | DN CH LOC-2, PBV End |
| 5. | CH5 | 37A/B | H.A LOC-1A, BHJA End |
| 6. | CH6 | 41A/B | SSLOC-2A, BHJA End |

5.3.2. EMERGENCY CRANK HANDLE RELEASE DURING FAILURE OF BOTH EI (ACTIVE & STAND BY) SYSTEMS:

When both the EI systems fails to operate due to power failure or whatever the reason, all the crank handles are released at a time. The SM on duty can set the

APPENDIX-‘B’

required point/ points through crank handles manually by extracting the key/keys from EKTs provided in the location boxes. The signaling staff i.e., JE/SSE/Sig or ESM shall be intimated immediately regarding the failure for rectification of the same.

5.4. BLOCK AND UNBLOCK (REMINDER COLLAR) OPERATION:

Block option is used to block the particular line on which SM on-duty is intended not to receive any train for certain period of time for some reason or the other.

5.4.1. BLOCK OPERATION:

To block/unblock a particular line, right clicking on the route button on concerned line displays ‘BLOCK’ and ‘UNBLOCK’ options on the menu as shown below.

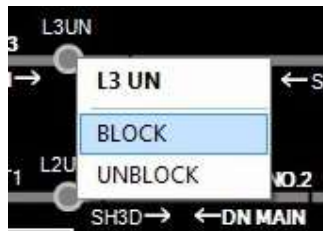

Then select the Line block option. After selecting the Line block option the particular line will be blocked for berthing portion on that particular line. The Line block ‘RED’ colour indication will be displayed after the successful application of such a blocking process on the VDU, during which no signal will be taken off for that line.

5.4.2. UNBLOCK OPERATION:

To unblock a line, place the mouse pointer over the blocked route button and press the right mouse button. A popup menu with block and unblock options will be displayed near that route button as shown above. Select the "UNBLOCK" menu item from the list and press the left mouse button. After selecting the line unblock option, that particular line will be available for the train movement leading to the all-possible track circuit section.

6. DIGITAL AXLE COUNTER:

Digital Axle Counters are provided as a Last Vehicle Checking Device (LVCD) for Both UP and DN block sections between MKRD-PBV and MKRD-BHJA.

For high reliability, High Availability Digital Axle Counters (HASSDAC) with dual detections are installed in MKRD-PBV and MKRD-BHJA section to ensure the working of at least on system at a time.

High Availability Single Section Digital Axle Counter (HASSDAC) consists of two Single Section Digital Axle Counters (SSDACs) are connected in parallel so that even anyone of the SSDAC fails which will not affect the system. These two Axle counters are named as SSDAC-1 and SSDAC-2. The status of each SSDAC is provided on the Reset box which is provided on the SM table.

| S.No | Indication | Automatic action taken by Equipment | Action by SM |
|------|---|-------------------------------------|--------------|
| 1. | Only SSDAC-1 fails after arrival of the train | System resets automatically | NIL |
| 2. | Only SSDAC-2 fails | System resets | NIL |

APPENDIX-'B'

| | | | |
|----|--|---------------------|---|
| | after arrival of the train | automatically | |
| 3. | Both SSDAC-1 & 2 Fails after arrival of the train (or)for any reason | No automatic action | SM to reset the system as procedure laid down in the Para No.6.1 and make an entry in the axle counter register. |
| 4. | Both SSDAC-1 & 2 Fails even after reset by SMS of both the end | No automatic action | Enter in Signal Failure Register issue failure memo to signal technician. Procedure to be adopted is same as laid down. |
| 5. | Either SSDAC-1 or SSDAC-2 fails continuously for long time | ----- | Report to signal staff without entering in signal failure |

The position of the Block section whether cleared or occupied are reflected in the VDU provided in the Station Master's office which shows 'GREEN' when the Block Section is clear and 'RED' when occupied. Whenever a train enters into the Block Section, "Block Section Clear" indication 'GREEN' for the particular block section disappears and 'RED' indication appears.

After complete arrival of the train the 'RED' indication will disappear and 'GREEN' indication will appear. If after the complete arrival of a train the 'RED' indication does not change to 'GREEN' it should be assumed as Block Instrument failure for the particular section and necessary action as per GR.14.13 is to be followed. The axle counters are interlocked with the respective block instruments for that section. If Axle Counter fails, Advanced Starter signal shall not come to 'OFF' and the concerned instrument shall remain locked in last operated position for that section.

In case of failure of both the Digital Axle Counters, the SM on duty should resort to resetting of the same along with the SM on duty of adjacent station after confirming that the whole of the train sent by sending station has been arrived at the receiving station. The resetting of the LVCD shall be initiated as mentioned below at both the stations after exchanging the Private Number vide G&SR 4.17, 4.17.01.

A Reset Box is provided on SM's table for each block section to reset the Axle Counter in case of failure of both the systems i.e HASSDAC. Reset Box gives the status of the block section i.e. Clear (GREEN), occupied (RED), preparatory reset (Miniature GREEN) and power on indications (WHITE). It also having the Reset Key, push button for resetting the LVCD and a counter is provided to record the operation.

Due to presence of the Girder bridge No.487 in the yard portion a Single Section Digital Axle Counter (SSDAC) 26XT is provided with line verification. Normally no indication will appear on track portion when 26XT is clear and red-light indication will appear on the track portion when 26XT is occupied.

In case of failure of 26XT a Reset Box is provided on SM's table and line verification box near the track portion. Reset Box gives the status of the track portion of 26XT i.e. Clear (GREEN), occupied (RED), Line verification (Miniature YELLOW) and power on indications (WHITE). It also having the Reset Key, push button for resetting the 26XT and a counter is provided to record the operation.

6.1. RESETTING OPERATION FOR LVCD (DIGITAL AXLE COUNTER):

After complete arrival of train, if the LVCD of the section does not clear and Block section clear indication (Green) does not appear in the VDU, the receiving station SM shall apprise the sending station SM through telephone for resetting the Axle Counter giving the details of last train that has arrived complete at his station and the block section is clear.

The receiving station shall inform the sending station as to whether the last train that entered into the section has arrived or not. And, if arrived fully shall so intimate the SM of sending station authenticated by exchanging Private number.

Then the SM on duty shall adopt the following resetting procedure at both the sending and receiving stations individually.

- a) On being advised by SM of MACHKUND ROAD Station, SM of PBV/BHJA should perform the following step by step procedure from (b) to (i) for resetting the Digital Axle Counter (HASSDAC).
- b) SM of MACHKUND ROAD Station and PBV/BHJA Station shall then Insert SM's reset key, and turn right.
- c) Press simultaneously both the Push button and the Reset Key which are provided on the Reset Box for at least 5 seconds continuously at MKRD and PBV/BHJA station.
- d) Release SM's Reset Key and Push button.
- e) Turn the SM's Reset Key to left and remove it.
- f) The system goes to preparatory reset state and preparatory reset miniature indication (Green) glows on the Reset box. The counter reading incremented after a gap of 5 seconds approximately.
- g) The counter reading should be recorded in the concerned register by SM on duty.
- h) One train is to be piloted out in the section to make the system normal.
- i) The SM on duty shall record it in the Train Signal Register indicating the resetting operations in detail i.e. train number, time, Private Number exchanged with SM of sending station and giving reasons for the resetting operation.
- j) If the axle counter works properly, then Block Section cleared indication 'Green' will appear on the Reset box and the concerned Block working will be normalized after arrival of train which is piloted out.
- k) If the LVCD section indication does not appear 'Green' and continues to show 'RED' indication, the concerned Block instrument shall be suspended and failure intimation is to be given to sectional signal Maintainer/JE/SE (Signal) for early rectification.

6.2. RESETTING OPERATION FOR 26XT (DIGITAL AXLE COUNTER):

Digital Axle counter 26XT is provided replacement of DN Advanced Starter Signal No.26 due to presence of Major Bridge at Km No.157.884 (BR No.487) to prove clearance/occupancy of the track. The occupation of the axle counter section is indicated on the VDU by RED.

APPENDIX-'B'

Due to any failure of Axle counter or after passage of a train, the Axle counter zone (26XT) shows occupation indication (Red) continuously on VDU, SM on duty shall indicate resetting procedure.

Before initiating resetting, on duty SM shall send a competent Railway servant deputed by SM, who in turn verify that the concern Axle Counter zone is clear of all obstruction then open the respective Line Verification box and press the verification button provided in the line verification box.

On obtaining verification indication which is indicated by glow of light on the Reset Box which is provided at SM's office, SM shall insert the key in the Reset Box, turns right and presses both the key and the Push button (Red) simultaneously and the same will be reset by this operation and concerned counter in counter box will change to the next higher number.

Number thus changed due to resetting shall be recorded in the TSR and in the reset register provided for this purpose.

7. SIGNAL LAMP FAILURE INDICATION AND BUZZER ACKNOWLEDGMENT:

LED signal lamps have been used for all signals at this station. In case of failure of any LED signal, will be indicated by showing 'RED' flashing light on VDU along with audible buzzer, which can be acknowledged and muted by pressing the 'ACK' button. However, the RED flashing light will continue to glow until the defective LED is replaced by a new LED. For rectification of failure SM on duty should inform the concerned S&T staff.

**8. POINT FAILURE INDICATION (RED), POINT FAILURE BUZZER AND POINT FAILURE ACKNOWLEDGEMENT:**

Whenever there is a failure of a point due to non-setting, flashing of concerned point indication and flashing of point failure indication (red) appears along with point failure Buzzer. The buzzer stops when acknowledge the respective 'ACK' button, but the flashing of concerned point indication and point failure indication shall continue to glow until the Point failure is rectified and disappear when point failure is rectified.

**9. COUNTERS:**

The following counters are provided for recording the actions such as emergency point operation, emergency route release etc. as shown in figure below would be displayed in rectangular boxes on the track layout window.

1. Emergency Route Release Counter.
2. Emergency Point Operation Counter.
3. Crank Handle Release Counter.
4. Up Calling on Counter.
5. DN Calling on Counter.

In addition to the above counters, a counter is provided on the Reset Box of each Block section LVCD. The increment in counter number for each and every such action should be recorded by the SS/SM on duty who shall record the details of the operation along with the latest counter number in a register.

10. TRACK CIRCUITS:

Both UP & DN main lines, UP Loop & DN loop lines and all the point zones are track circuited as L1T1, L1T2, L1T3, L1T4, L2T1, L2T2, L2T3, L3T1, L3T2, L3T3, L4T1, L4T2, L4T3, 33AT, 33BT, 35T, 34T, 32BT, 32AT.

Approach track circuits 1AT & 2AT of 5 Rail length for Calling on Signal are provided in rear of the Up and DN Home signals respectively. In addition, there are short length track circuits 2T1 & 2T2 in advance of DN Home Signal and 1T1 and 1T2 in advance of UP Home Signal are also provided. Similarly, there are 120M length track circuit 25T beyond UP Advanced Starter Signals for replacement of Last Stop Signal. From the last trailing point/fouling mark in either side of yard to Advanced Starter Signals are also track Circuited i.e 26AT and 25AT in DN and UP directions respectively.

Indications for the above track circuits are available on VDU. Yellow Strip on VDU indicates Route is set and track is clear and Red strip indicates Track is in occupied condition.

On account of the doubtful operation of any track circuit by a light vehicle including self-propelled vehicle such as motor trolley or light engine or tower wagon etc., indicating the occupancy/clearance of track, it is necessary that the Station Master on duty satisfies himself that the said vehicle has cleared the point zone track circuits by observing the track indications of the track on either side of the cross overs by positively checking the entrance and exit track circuits are showing occupancy and clearance in accordance with the train movement.

11. RELEASE/CANCELLATION OF ROUTE:

Normally when a train is received on or dispatch from any route, the route illumination will disappear automatically after passage of the train suggesting that the route is released. When the route is not released automatically after passage of train over it or when on SM on duty intends to cancel the route set by him shall follow the procedure for cancellation of route described in Para No.5.1 of Appendix-B above. If the route is not released even after resorting to cancellation the SM on duty should inform the Signal Maintainer/JE/SSE for its rectification.

Note: UP & DN Calling on Signals and UP & DN Advanced Starter Signals are to be manually cancelled after the passage of the train to release the route. In both the cases after passage of train, cancel the signal to release the route.

12. REPLACEMENT OF SIGNALS TO 'ON':

Signals are replaced to 'ON' automatically by the passage of a train beyond the signal. It will not be possible to re-clear the signal again unless the due process for clearing the signal is repeated again. For replacement of any signal to 'ON' position manually, the SM on duty shall follow the Para No.5.1 of Appendix-B.

13. PILOTING OF TRAINS IN TO STATION YARD:

Whenever Home signal becomes defective, trains can be admitted by taking off Calling-on signal. Whenever both Home signal and Calling-on signal failed, all trains will be piloted in vide SR. [Refer SR 3.69.06].

If after the operation from the VDU, the approach stop signal fails to take 'off' the SM shall personally ensure from the indications displayed in the VDU that the route is clear, the points indications (including isolation point), crank handle 'IN' indication for the entire route and overlap portion (if any) are lit and remains steady and thereby fulfilling all the requirements of taking off signal. SM's key provided in VDU is to be taken out and after that only reception of trains on defective signal may be arranged without clamping and padlocking of points of concerned route. The loco pilot shall be issued form T/369(3b) or T/369(1) in accordance with GR.3.69. No route cancellation operations of the concerned route are to be initiated till the total completion of the train movement.

Where the point, lock and route indications are fails to appear in the VDU, the SM on duty shall ensure the clearance of the nominated route, proper setting of all points through crank handle operation and get all the points whether facing or trailing clamped and padlocked with the help of TPM.

The SM on duty shall then hand over the written authority (T/369(3b) to the TPM for piloting the train. While going towards Home signal the TPM shall check the points and satisfy himself that the route is correctly set.

After the train has brought to a dead stop at the Home signal the TPM shall hand over the pilot memo to the Loco pilot, board the engine and display proceed hand signal to pass the Home signal.

NOTE:

- a) The Station Master on duty shall personally supervise the correct setting, clamping and padlocking of the facing points, if any and ensure clearance on the nominated route vide SR [Ref. SR 3.69.03(c)].
- b) The keys of padlock of the clamps put on to the points on the route for piloting In or piloting OUT shall be in the personally custody of the SM on duty or any other authorized operating officials till such time the train / engine / vehicle has utilized the route or alternatively such movement is cancelled.

14. PILOTING OF TRAINS - OUT OF STATION YARD:

When the starter signal has become defective, the Station Master on duty shall follow the procedure laid down in the SR.3.70.03. Then the SM on duty shall hand over the pilot memo T/369(3b) (along with the other authority if necessary) to the on duty TPM. The TPM on duty shall hand over the authority to the Loco pilot of the train and display proceed hand signal at the foot of the starter vide SR. [Refer SR 3.70.01].

In case the advanced starter signal has become defective, such signal shall be passed on the written authority on the form T/369(3b). The TPM shall hand over the pilot memo in form T/369(3b) to the Loco pilot after the train stopped. [Refer SR 3.70.02].

15. SHUNTING:

APPENDIX-'B'

Shunt back signals SH3(A/B) and SH4(A/B) are provided towards BHJA end of the yard and towards PBV end of the yard respectively. Dependent shunt signals SH9 & SH11 are provided on Line No.1 & 2 towards PBV end respectively and SH10 & SH12 are provided on Line No.4 & 3 towards BHJA end respectively. For taking OFF Shunt signals please refer Para No. 4.6.2 of APPENDIX-B.

16. VERIFICATION OF LINE CLEARANCE BY STATION MASTER ON DUTY FOR RECEPTION OF TRAIN INTO STATION YARD:

In the Station yard, a route on the running line comprises entrance, berthing and dispatch portion of the yard shall be kept clear of any obstruction for the passages of any train or for any other movements. The clearance of the route including overlap must be ensured by the SM on duty personally through VDU indications and/or physical verification of track before any movement of trains are permitted on the concerned route subject to the other conditions such as locking of the point's etc.

17. OBSERVATION OF TRACK CIRCUIT AFTER STABLING OF TRAINS ON RUNNING LINES:

When a train is stabled on a running line for a duration exceeding ten hours, the use of the said running line for passing the trains 'IN' 'THROUGH' or 'OUT' at the station shall be done with a lot of care and diligence. Station Master on duty shall meticulously observe the proper functioning of the relevant track circuits (occupancy/clearance) while admitting a train. Such observance should continue for a minimum of four to five trains thereafter. If the Station Master on duty is not satisfied with the proper functioning of the track circuits on which the train was earlier stabled, the signals leading on the line shall be suspended and the S & T maintenance staff be informed to attend.

18. MAINTENANCE OF S & T INSTALLATION AND ADHERENCE TO MAINTENANCE SCHEDULES:

Regular maintenance of the S&T installations, adherence to schedules of maintenance testing of points, track circuits, level crossing gates, associated interlocking apparatus cables and the interlocking functional tests is must for safe and satisfactory working of these installations at this station.

The tests, checks and replacements etc., shall confirm to the schedules of maintenance as indicated in the Signal Engineering Manual as also as per the current and extant instructions/circulars on the subject.

19. HOT AXLE SIDING:

Hot Axle Siding with CSL of 57M (GJ to DS) is takes off from Line No.1 towards BHJA end and terminates towards Sub Station end and isolated from the Line No.1 with DS. To operate the Siding point the following procedure as follows:

19.1. WORKING OF HOT AXLE SIDING POINT NO.37A/B:

Electrical operation of siding control point No.39 is carried out at site from the Siding point 37A/B location No.1. In Siding point 37A/B location No.1 there are two EKT's namely EKT-1 & EKT-2, three buttons for normal and reverse operation along with common button. Point indications for normal & reverse and point free indications are provided. Working of Electrical operation of Siding Points is as follows:

1. To operate Siding point Key 'P' is required to be inserted in EKT-2.
2. Key 'P' can be extracted from EKT-1 only when SM extends permission from VDU (as per the procedure in Para No.4.8 of this appendix). Extraction of Key 'P' from the EKT-1 will block all signaled movement on Line No.1.

APPENDIX-'B'

3. Key 'P' when inserted in EKT-2, point free indication appears on the board. Point button and normal or reverse buttons are simultaneously pressed to set the point to normal or reverse as the case may be.
4. After setting of point to reverse key 'P' should be extracted from EKT-2 and kept in the custody of the staff deputed by SM for the operation. Removal of key will lock the point.
5. After completion of the movement key 'P' is to be inserted in EKT-2 & siding point 37A/B is to be operated to normal. After ensuring both the ends of 37A/B in normal, Key 'P' is extracted from EKT-2 & inserted in EKT-1 to enable SM to release the control 37. Key 'P' in EKT-1 resume signaling movement over 37A/B in normal position.
6. Crank handle control CH-5 is to be taken out for crank handling the point 37A/B in case of failure of electrical operation.
7. To extract the crank handle CH-5 from RKT provided in H.A Location-1A, SM on duty should extend the control no.37 same as for electrical operation of siding point.

20. SUB STATION SIDING:

Sub Station Siding with CSL of 58M (DS to GJ) is takes off from Line No.1 towards Station end and terminates towards Hot Axle Siding end and isolated from the Line No.1 with DS. To operate the Siding point the following procedure as follows:

20.1. WORKING OF SUB STATION SIDING POINT NO.41A/B:

Electrical operation of siding control point No.41 is carried out at site from the Siding point 41A/B location No.2. In Siding point 41A/B location No.2 there are the two EKT's namely EKT-1 & EKT-2, three buttons for normal and reverse operation along with common button. Point indications for normal & reverse and point lock/free indications are provided. Working of Electrical operation of Siding Points is as follows:

1. To operate Siding point Key 'Q' is required to be inserted in EKT-2.
2. Key 'Q' can be extracted from EKT-1 only when SM extends permission from VDU. Extraction of Key 'Q' from the EKT-1 will block all signaled movement on Line No.1.
3. Key 'Q' when inserted in EKT-2, point free indication appears on the board. Point button and normal or reverse buttons are simultaneously pressed to set the point to normal or reverse as the case may be.
4. After setting of point to reverse key 'Q' should be extracted from EKT-2 and kept in the custody of the staff deputed by SM for its operation. Removal of key will lock the point.
5. After completion of the movement key 'Q' is to be inserted in EKT-2 & siding point 41A/B is to be operated to normal. After ensuring both the ends of 41A/B in normal, Key 'Q' is extracted from EKT-2 & inserted in EKT-1 to enable SM to release the control 41. Key 'Q' in EKT-1 resume signaling movement over 41A/B in normal position.
6. Crank handle control CH-6 is to be taken out for crank handling the point 41A/B in case of failure of electrical operation.
7. To extract the crank handle CH-6 from RKT provided in SS Location-2A, SM on duty should extend the control no.41 same as for electrical operation of siding point.

21. RECTIFICATION AND CHECK BEFORE RESUMING NORMAL WORKING:

APPENDIX-'B'

After receipt of the failure information, the sectional Maintainer shall attend to the failure after giving a 'Disconnection Memo'. After rectification of the fault, the Sectional Maintainer shall give 'Reconnection Memo' detailing the rectification. Thereafter the Station Master on duty shall personally check this defective apparatus. After satisfying himself that the gear is in good and proper working order, he shall resume the normal working of the said defective apparatus in terms of SR.3.68.04 (C) and (D).

22. PROCEDURE FOR CARRYING OUT PLANNED MAINTENANCE WORK:

Whenever any normal maintenance or special works for major renewals etc., are involved, the Signal and Telecom department should pre-plan these works. Field staff and the Inspector of the section should give to the Station master in writing 'Advance Intimation' about this work in terms of G and SR.15.08.01.

23. EMERGENCIES:

Notwithstanding, anything contained in the aforesaid paras when equipment is found defective and unsafe for passage of trains, the Signal and Telecom staff must at once suspend the working of the equipment and associated installations and issue 'Suspension Memo' explaining the seriousness of the defect or damage to the interlocking installation to the Station master and take the Station Master's acknowledgement. After this, the usual practice of exchange of disconnection memo and reconnection memo can follow. The Station Master must act promptly on such messages and take adequate precaution treating the S&T installation as defective and pass trains over the affected interlocking equipment's according to extant instructions as contained in GR and SR.3.77.

24. PROCEDURE TO BE FOLLOWED IN CASE OF FAILURE OF SIGNAL OR POINTS AND USE OF CRANK HANDLE:

1. Whenever a Signal or a Point becomes defective any movements over the Points on the running lines should be made after clamping and padlocking both the facing and trailing Points by Station Master on duty personally for all trains at the Station.
2. In case of failure of Signal or a Point and in case the Point cannot be operated from the VDU, the Crank Handle which is interlocked with the system has to be extracted and the following procedure has to be observed.
3. One common emergency Crank Handle key is provided for certain group of Motor operated Points. This is mechanically riveted to the Key of RKT. This Key along with Crank Handle can be released from the RKT by pressing the RKT Push Button provided near the RKT. In case of failure of Point Motor, the SM on duty will take out the Crank Handle, set the Point manually by inserting Crank Handle in the Motor.
4. When the Crank Handle key is removed from RKT for operation of the defective Motor Operated Points, the responsibility for its safe custody rests with the ASM/SM on duty till it is replaced back in RKT.
5. The failure of Motor Operated Points should be promptly reported to the concerned Signal Inspector/ESM for immediate rectification.
6. Whenever a Crank Handle key is required to be used by a Signal Official for maintenance/attending to failure, the Signal Official will give a disconnection memo to the Station Master on duty and after making necessary entries in the Crank Handle register, the Station Master on duty will obtain acknowledgement

APPENDIX-'B'

of the Signal Official in the Crank Handle Register and then handover to him the Crank Handle key for the Points concerned. All the Points will be treated as defective till the Crank Handle key is returned back to Station Master on duty.

7. Before parting with the Crank Handle either for attending failure or for Maintenance work by Signal Maintenance Officials, the Station Master on duty will ensure that the reception and departure Signals are put back to on position. The Points of all the lines should be treated as Non-interlocked and the Station Master on duty is responsible for introduction of Non-interlocked working and the trains will piloted IN and OUT duly clamping and Padlocking the Points, both in facing and trailing directions over which the train is to pass, as per GR 3.69 and 3.70 with relevant SR's. The Station Master on duty will be personally responsible for setting and locking of Points, for reception and dispatch of all trains.
8. The Crank Handle Register is to be maintained in the following pro-forma by the Station Master on duty wherein the particulars of usage of the Crank Handle must be recorded:
 - a. Date:
 - b. Point Number which failed or required to be tested:
 - c. Time failure:
 - d. Disconnection memo number received from S&T Staff:
 - e. Signature of SM/Signal Official to whom the Emergency Crank Handle is handed over:
 - f. Time Emergency Crank Handle is sent out:
 - g. Individual Point numbers, and Line number nominated for admission of dispatch for which Points are set, Clamped and Padlocked:
 - h. Train number to be admitted or dispatched:
 - i. Signature of the Station Master on duty to ensure correct setting, Clamping and Padlocking of the Points:
 - j. Date and Time fault rectified.
 - k. Time of Emergency Crank Handle received back by SM on duty:
 - l. Signature and Designation of the Signal Official who rectified the fault:

25. INTERLOCKING OF SIGNALS WITH BLOCK INSTRUMENTS:**25.1. INTERLOCKING WITH HOME SIGNALS:**

All the UP and DOWNHOME Signals are Electrically interlocked with the respective DLBI so that the handle of the DLBI Instrument cannot be turned from TRAIN ON LINE position to LINE CLOSED position of UP or DOWN direction as the case may be unless the respective Home Signals is put back to NORMAL position and the respective Block Section monitored by Axle Counter is clear of trains.

25.2. INTERLOCKING WITH ADVANCED STARTER SIGNALS:

The UP Advanced Starter Signals No.25 is electrically interlocked with respective DLBI of section MKRD-PBV so that this Signal cannot be taken OFF until the Handle of the concerned Block Instrument is in 'LINE CLEAR' position.

The DN advanced starter signal No.26 is interlocked with DLBI of section MKRD-BHJA so that this Signal cannot be taken OFF until the Handle of the concerned Block Instrument is in 'LINE CLEAR' position.

25.3. SUSPENSION OF LAST STOP SIGNALS:

APPENDIX-'B'

When the Double line block instrument for section MKRD-PBVis suspended with its handle in any position for whatever reason the concerned Last Stop Signals controlled by the DLBI must be treated as suspended and trains shall be Piloted Out.

When the Double line block instrument for section MKRD-BHJAis suspended with its handle in any position for whatever reason the concerned Last Stop Signals controlled by the DLBI must be treated as suspended and trains shall be Piloted Out.

26. NORMALISATION OF THE BLOCK SECTION AXLE COUNTER AND OF BLOCK WORKING BY RESETTING FEATURE:

1. High availability Digital Axle Counters (HASSDAC) are provided on Up and Down Block Sections between MKRD-PBVand MKRD-BHJA.
2. The occupation and clearance of the axle counter section are indicated on the VDU by 'RED' and 'GREEN' light.
3. If any Block proving Axle Counter [LVCD] section fails, the Last Stop Signal at the rear station cannot be taken 'OFF' and Block instrument at Advance Station cannot be turned 'Line Closed' position after arrival of a train and in such case, resetting of last Vehicle Checking Device is to be resorted to in either Section.
4. No train shall be allowed on signal to leave a station in any particular direction unless:

Block Section clear indication is available for the relevant Axle Counter section portion and Last Stop Signal is taken OFF. [Refer Para No: 6.1 of appendix 'B' for procedure of resetting of LVCD Axle counter].

27. POWER SUPPLY ARRANGEMENT FOR SIGNALLING INSTALLATIONS:

Power signaling and interlocking installations and the ancillary field units are fed from the following sources of power supply.

- a) Normal supply from UP AT/ DN AT connected to OHE traction distribution [230V 50HZ].
- b) Stand by supply: Odisha State Electricity Board Supply.

Normal power supply [Single-phase 230V-50 HZ] to the signalling and interlocking installation at the station is drawn from the traction power sources through ATs. Whenever traction power supply fails the SM on duty shall operate the changeover switch provided in the SM's office connecting the power supply from the healthy sources to the installation in case the knob is not in Auto mode.

The SM on duty however maintain the record of power failures either of the traction supply or local supply and he must promptly report the failure of any one or both the power sources immediately through the section controller and to the concerned Elect. Staff and S&T maintenance staff.

- i). An Auto change over switch is provided in the SM's office with the three power supplies viz., UP AT, DN AT and local for the changing the switch automatically to the available supply. The availability of the supply is indicated by luminous indicator above the circuit breaker for each supply.
- ii). Normally the switch will be kept in Auto Mode. If the Switch kept towards UP AT/DN AT position, whenever power block is to be given on the line the on-duty

APPENDIX-'B'

SM on duty must ascertain that power is available on the other AT and change over the switch to the desired position.

NOTE: If power block is to be given on the UP line DN AT must be available and vice versa.

- iii). In case of failure of one of the AT supply without any power block the on-duty SM has to check whether the circuit breaker has tripped [Three circuit breakers are provided in the changeover switch board, one for each supply and their normal position is down and when tripped it goes UP].

In case of failure of both AT supplies without any power block the local supply shall be utilized by operating the changeover switch. If the circuit breaker is tripping even after resetting, no attempt shall be made to hold it by any means and a message shall be given to concerned SSE [Elect.] and SSE/PSI [OHE] for prompt rectification.

- iv). Whenever there is failure of power supply in one AT the SM on duty shall take prompt action to inform to all concerned for rectification.

The on-duty SM himself during each shift shall check & test the availability of power supply on both ATs and make an entry in the station dairy duly initiating for rectification of failure if any.

- v). For IPS system which provides supply to EI, a manual changeover switch is provided at SM's Office with the power supply viz., selected supply from CLS panel.
- vi). Normally manual changeover switch is kept in selected supply from CLS panel position, if in case any emergency, changeover switch is changed to middle position by on duty SM to cut off the power supply to IPS.
- vii). There is a remote monitoring ASM box provided at the station to monitor the health of IPS.

28. WORKING OF INTEGRATED POWER SUPPLY [IPS, INDICATIONS & ACTION TO BE TAKEN BY SM ON DUTY:

Power supply to the signalling installation is fed through Integrated Power Supply System [IPS] installed in the S&T power supply room. For IPS system, a manual changeover switch is provided at SM's Office with the two power supplies viz., selected supply from CLS panel and DG supply for changing the switch to required supply position. Normally manual changeover switch is kept in selected supply from CLS panel position, if in case any emergency changeover switch is changed to DG supply position. There is a remote monitoring ASM box provided at the station to monitor the health of IPS.

The IPS system is connected with battery as a backup power source for safe working during transition of power and in case no 230 AC supply is available due to any reason.

In the event of failures of all the sources of 230V 50HZ AC supply, the signalling system shall be fed by backup battery bank connected to IPS for a limited power of 8 to 10 hours. The health of the battery bank is monitored through one IPS Monitoring Panel provided in the SM's room which shall display the voltage of 110V DC battery bank provided as backup source of power supply. Depending up on the health of the battery bank and the system the following indications/alarm will appear on the remote monitoring panel. The

APPENDIX-'B'

indications/alarm, their implications and action to be taken by SM on duty is tabulated below:

| SN | Instruction | Health of Battery Bank/Equipment. | Visual Indication | Audio Indication | Action to be taken by SM on duty |
|----|-----------------|-----------------------------------|-------------------|------------------|--|
| A | - | 50% DOD | Red | Alarm | Alarm shall be acknowledged by SM on duty. |
| B | - | 60% DOD | Red | Alarm | -do- |
| C | System shutdown | 70% DOD | Red | Alarm | Signal feed cut off and all DC-DC converters to Work. Audio alarm will continue till power Supply is restored. |
| D | Call S&T staff. | Equipment fault. | Red | Alarm | Failure of any module will give the alarm in ASM's panel. Alarm shall be acknowledged by SM on duty for audio cut off. |

On duty SM in each shift shall check and record the readings, indications, etc. in the station dairy duly initiating rectification of failures of IPS System, if any. In the event of failure of Remote monitoring ASM console due to any reason when both traction power and local power failed the SM on duty shall inform concerned Electrical staff immediately. In case 'call S&T staff 'or 'system shut down 'indication appear on the remote monitoring panel of IPS and/ or malfunctioning of the remote monitoring panel SM on duty shall inform the same to concerned S&T staff immediately.

NOTE: [i] DOD indicates depth of discharge of battery bank of IPS [ii] In case of failure of all AC supply sources, IPS battery bank can provide power supply maximum up to 3 to 4 hours before system shut down indication of APS.

29. WORKING OF AUTOMATIC FIRE ALARM DETECTION SYSTEM:

- In case of any alarm in any particular area due to fire or dust-Zone number on the LCD display can be seen.
- Note down the zone No. and panel display name, by referring display chart.
- Once you find the zone number rush to that particular area where the detector gives alarm.
- The moment the smoke detector detects any smoke particles, the RED LED will blink along with the alarm.
- Once you reach the area where the detector is giving the alarm, check whether the alarm is due to the fire or for any other reason.

APPENDIX-'B'

- To alert the people in case of emergency press “*” sign of the fire which is present inside the key pad together for few seconds. This will enable you to hear the panel alarm.
- To reset the panel press “OFF” button and enter the code 1111 (1 digit four times).
- The control panel will get reset and siren muted.
- If the power fails on this will enable us to see the red indicator on the panel.
- In case of failure in power and if the battery is fully charged, the panel can function effectively as long as the charge in the battery is present.

AUTO DIALLING:

If you hear alarm from the panel, this system will dial the telephone/mobile number you fed. The pre recorded messages will be heard on the phone. If you want to make two way communications, press “6” on your mobile. You can have this communication for 50 seconds. If you want to talk more, press again “6” before completion of 50 seconds for another 50 seconds or you can acknowledge the receipt of call by pressing “2” on SSE/Signal mobile, in case number “2” is not pressed the system will dial again the same telephone number as per the programmed dial attempt and still if acknowledgement not come from 1st number then panel will dial 2nd number till the time acknowledgement comes it will keep on dialing.

APPENDIX 'C'

ANTI COLLISION DEVICE [RAKSHA KAVACH]:

-NIL-

APPENDIX 'D'

DUTIES OF TRAIN PASSING STAFF AND STAFF IN EACH SHIFT

The following staffs are concerned with the movement of the trains whose duties are given below:

1. STATION MASTER (IN CHARGE):

- i) He is responsible for trains passing during his shift.
- ii) He is responsible for the general and satisfactory working of the station and for the efficient discharge of duties by staff working under him.
- iii) He shall keep all Rule books, Registers, Files and documents neat and up to date.
- iv) He shall ensure that all equipment, apparatus, and instruments including signaling and interlocking gears and fittings are kept clean and oiled by S&T officials.
- v) His special attention is drawn to Chapter-II of G&SR and GR 5.01 to 5.08 with relevant SRs and O.M. Chapter-2.
- vi) He shall follow the instructions laid down in SR.3.68.01 (c) and (d) and SR 14.07.01 and B.W.M.2.09 (e).
- vii) He shall promptly attend to accidents and report them.
- viii) He shall supervise the work of safe working staff and conduct night inspections and report lapses of staff working under him.

2. STATION MASTER:

- a) He is responsible for trains passing during his shift.
- b) He shall promptly bring to the notice of SM in-charge all irregularities and accidents in course of his shift duties.
- c) During the absence of SM I/C, the duties of the Station Master will devolve on him.
- d) He shall follow SR 3.68.01(c) and (d) SR 14.07.1 and OM Chapter-2.
- e) His special attention is drawn to Chapter-2 of G&SR 1976 and GR 5.01 to 5.08 with relevant SRs.
- f) As an assistant to SM I/C, he shall carry out the instructions given from time to time.

3. TRAFFIC POINTSMAN:

- i) He shall work under the orders SM on duty.
- ii) He shall couple and uncouple vehicles under the supervision of SM.

APPENDIX-'D'

- iii) He shall watch and guard the packages and other Railway property lying in the Station premises.
- iv) He shall report any irregularities coming to his notice.
- v) He shall do loading and unloading of parcels, smalls and Guard's boxes. He shall do piloting IN and OUT.
- vi) He shall deliver any official message to the proper person/office. He shall carry out any other duties entrusted to him by the SM on duty.
- vii) He shall follow OM Chapter-2.

APPENDIX 'E'

LIST OF ESSENTIAL EQUIPMENTS PROVIDED AT THE STATION:

A list of essential equipment's is given below which shall be maintained in good Working order.

| Sl. No | Description | Quantity |
|---------------|--------------------------------------|-----------------|
| (i) | Detonators | 20 |
| (ii) | LED based Tri Colour flashing torch. | 3(1 Spare) |
| (iii) | Hand Signal Flags | 3(1 Spare) |
| (iv) | Safety chains with Pad locks | 6 |
| (v) | Clamps with Padlocks | 8 |
| (vi) | Skids | 6 |
| (vii) | Wedges | 4 |
| (viii) | Fire & Sand buckets | 2 |
| (ix) | Fire Extinguishers | 2 |
| (x) | Line blocking collars | 6 |
| (xi) | Motor trolley on line board | 2 |
| (xii) | Block suspension board | 2 |



APPENDIX 'F'

RULES FOR WORKING OF DK STATIONS, HALTS, IBH, IBS AND OUTLYING SIDINGS

--NIL--



APPENDIX- 'G'

MACHKUND ROAD STATION

RULES FOR WORKING OF TRAINS IN ELECTRIFIED SECTIONS:

DETAILS OF WORKING RULES OF 25KV AC TRACTION.